



# R Series® Configuration Manual

---

The issue date for the R Series Configuration Manual (**REF 9650-0902-05 Rev. K**) is **September, 2022**.  
Copyright © 2022 ZOLL Medical Corporation. All rights reserved. R Series, pedi-padz, Real CPR Help, See-Thru CPR, Perfusion Performance Indicator, CPR Dashboard, Code-Ready, and OneStep are trademarks or registered trademarks of ZOLL Medical Corporation in the United States and/or other countries.

Masimo is a registered trademark of Masimo Corporation in the United States and/or other countries.

All other trademarks are the property of their respective owners.

 **ZOLL Medical Corporation**  
269 Mill Road  
Chelmsford, MA USA  
01824-4105



**EC REP** **ZOLL International Holding B.V.**  
Newtonweg 18  
6662 PV ELST  
The Netherlands

**CH REP** **ZOLL Medical Switzerland A.G.**  
Bahnhofstrasse 20  
6300, Zug  
Switzerland

  
0123

---

# Table of Contents

## Chapter 1 Introduction

Entering System Configuration Mode .....	2
Printing Configuration Settings and Activity Logs .....	3
Uploading Data from a Compact Flash Card .....	7
Saving Configuration to a Compact Flash Card .....	9
Restoring Default Values .....	10
Accessing and Changing Configuration Settings.....	11
Leaving Configuration Mode.....	12

## Chapter 2 Configuration Settings

General Settings .....	14
Device Identifier .....	14
Configuration Mode Passcode .....	16
Code Markers .....	17
ECG Settings .....	19
Notch Filter .....	19
Display Lead on Power-Up .....	19
Frequency Response .....	19
ECG waveform size on Power Up .....	20
Enable Leads Off .....	20
Enable Pacer Detection .....	20
Display ECG Scale .....	21
Audio Settings.....	22
QRS Volume on Power-Up .....	22
Low Battery Tone .....	22
Enable Corrective Voice Prompts .....	22
Voice Prompt Volume (1 = Min, 3 = Max) .....	23
Silence Message Beeps .....	23
Basic Defibrillation Settings .....	24
Defib Default to Pads .....	24
Basic Auto Energy Escalation .....	24
Retain Sync After Defib .....	24
Defib Ready Hold Time .....	25
Enable Remote Sync .....	25
Highlight Sync On/Off Softkey .....	25
Advisory Defib.....	26
Energy Level: Shock 1 .....	26
Energy Level: Shock 2 .....	27
Energy Level: Shock 3 .....	27
Ped Energy Level Shock 1 .....	27
Ped Energy Level Shock 2 .....	28
Ped Energy Level Shock 3 .....	28

Auto Analyze .....	28
Enable Check Pulse Prompt .....	29
Check Patient Prompt .....	29
Auto Charge in Advisory Mode .....	29
Enable Voice in Advisory Mode .....	30
Display DO CPR Message .....	30
CPR Message After No Shock Advised .....	31
CPR Message After Shock .....	31
Stacked Shocks .....	32
Restart Analysis After CPR .....	32
CPR Interval .....	32
Stop CPR Prompt .....	32
CPR Settings .....	33
Enable CPR Voice Prompts .....	33
Enable CPR Display .....	33
Enable CPR Dashboard .....	33
Display Release Bar .....	34
Enable CPR Metronome .....	34
Target CPR Depth .....	34
CPR Depth Units .....	34
Display Fully Release Prompt .....	35
Display Filtered ECG as Top Trace .....	35
Metronome Tone .....	35
Pace Settings.....	36
Pace Rate Setting on Power-Up .....	36
Async (Fixed) Softkey in Pace Mode .....	36
Async or Fixed Pace Labels .....	36
Alarms Settings.....	37
Alarm Limits at Power Up .....	38
Alarms Active at Power Up .....	42
Display Settings .....	43
Display Time .....	43
Select Trace 2 At Power Up .....	43
Select Trace 3 At Power Up .....	44
ECG Color .....	44
SpO <sub>2</sub> Color .....	44
CPR Color .....	44
EtCO <sub>2</sub> Color .....	45
NIBP Color .....	45
SPO <sub>2</sub> at Power Up .....	45
Display Shock Count in Manual Mode .....	45
NIBP Settings (Optional).....	46
Blood Pressure Units .....	46
Trigger NIBP Meas on BP Alarm .....	46
Trigger NIBP Meas on HR Alarm .....	46
NIBP Auto Interval Default .....	47
Adult Initial Cuff Inflation .....	47
Pediatric Initial Cuff Inflation .....	47
Neonatal Initial Cuff Inflation .....	47

---

NIBP Patient Mode at Power Up .....	48
NIBP Button Press & Hold .....	48
Enable Motion Tolerance .....	48
EtCO <sub>2</sub> Settings (Optional).....	49
Default EtCO <sub>2</sub> Units .....	49
Displayed Zoom Level .....	49
Default EtCO <sub>2</sub> Comp Setting .....	49
Power Save Mode at Power Up .....	50
EtCO <sub>2</sub> Average On Power Up .....	50
Printer & Report Settings .....	51
Set Report Restart Delays .....	51
Auto Generate Strips .....	51
Print 3 Leads When Leads Sel. ....	51
Readiness Test Settings .....	52
Automatic Readiness Test .....	52
Readiness Test Time .....	52
Print Readiness Test Results .....	52
Enable Readiness Test Audible Alert (Future Use) .....	53
One Step Padz Installed .....	53
AED Mode .....	54
Display ECG in AED Mode .....	54
Display HR in AED Mode .....	54
Manual Confirm Enable .....	54
Extra CPR Interval Before 1st Analysis .....	55
Duration of Extra CPR Interval .....	55
Display Remaining CPR Timer .....	55
Wi-Fi Settings (Optional).....	56
Configuring a Wi-Fi Card .....	56
Copying a Wi-Fi Configuration to Another Wi-Fi Card .....	57
Entering Alphanumeric Information .....	57
Wi-Fi Menu Options .....	58
Network Profile Submenu Options .....	63
Certificate Setup .....	65
Wi-Fi Authentication Network Configuration Procedures .....	69
Data Transfer Settings (Optional) .....	80
Full Disclosure Transfer Mode .....	80
Defib History Transfer Mode .....	80
Enable Report ID .....	80
Time Sync .....	81
Report Transfer Reminder .....	81
Enable Auto Case Upload .....	81
Delete After Auto Case Upload .....	81
Send .DCK File With .FUL File .....	82



# Chapter 1

## Introduction

---

The R Series<sup>®</sup> is designed with several user selectable features that allow operators to configure the device according to their protocols and local requirements. This manual describes the configuration settings (options and defaults) and how to change them for ALS, Plus, and BLS models. References to AED settings are for Plus and BLS models only.

**Note:** Your unit may not contain all features listed. For BLS/Plus units, some features are available in manual mode operation only.

For more information, see the following sections:

- “Entering System Configuration Mode” on page 2
- “Printing Configuration Settings and Activity Logs” on page 3
- “Uploading Data from a Compact Flash Card” on page 7
- “Saving Configuration to a Compact Flash Card” on page 9
- “Restoring Default Values” on page 10
- “Accessing and Changing Configuration Settings” on page 11
- “Leaving Configuration Mode” on page 12

# Entering System Configuration Mode

In order to make any changes to unit configuration, you must first power on the unit in System Configuration mode.

## Procedure

Follow these steps to power on the unit in System Configuration mode:

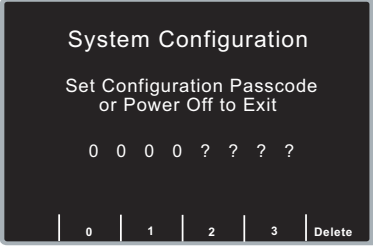
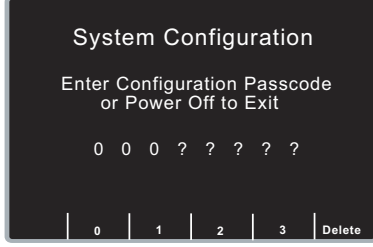
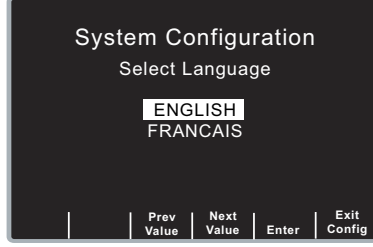
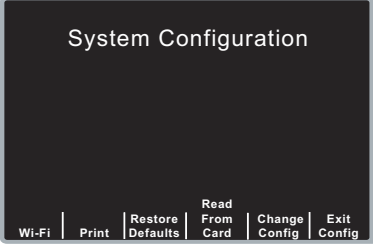
Step	Action
1.	<p>Turn the selector switch to OFF, and wait 10 seconds.</p> <p>Simultaneously press and hold the right-most and left-most softkeys (below the monitor) while turning the selector switch to MONITOR (for ALS models) or ON (for Plus and BLS models), and hold the softkeys for approximately 4 seconds.</p> <p>The unit powers on in System Configuration mode.</p> 
2.	<p>Enter the passcode using the appropriate softkeys.</p> <p><b>Note:</b> When you enter System Configuration for the first time, enter the default pass code of <b>00000000</b>.</p> <p>To change a digit, use the <b>Delete</b> softkey to highlight the entry and re-enter the digit.</p> <p>When all 8 digits have been entered, the unit automatically advances to the Select Language screen.</p> 
3.	<p>Use the <b>Prev Value</b> and <b>Next Value</b> softkeys to toggle the highlighted area between the language options.</p> 
4.	<p>Press the <b>Enter</b> softkey to select the highlighted language.</p> <p>All subsequent configuration menus will be in the selected language.</p> <p>The unit automatically advances to the Main Configuration menu.</p> 



# Printing Configuration Settings and Activity Logs

To print the current configuration or activity log of your unit while the unit is in the System Configuration mode, press the **Print** softkey from the Main System Configuration menu. For instructions on putting the unit in System Configuration mode, refer to the previous section, “Entering System Configuration Mode.”

## Printing Configuration Settings

In System Configuration mode, press the **Print** softkey, then the **Print Config** softkey to print a stripchart of all the unit’s configuration settings. See a copy of a sample Configuration Report below.

**Note:** In normal operation, you can print the configuration by pressing the following softkeys: **Options**, **More**, then **Print Config**.

ZOLL R SERIES CONFIGURATION REPORT		GLOBAL OPTIONS		BASIC DEFIB OPTIONS	
SYSTEM SERIAL NUM	00008227	NOTCH FILTER	60 Hz	DEFIB LEAD DEFAULT TO PADS	Yes
SW REL NUM	07.53	LOW BATTERY TONE	5 Min	BASIC AUTO ENERGY ESCALATION	Yes
Boot Version	0250h	DISPLAY TIME	Elapsed Time	RETAIN SYNC AFTER DEFIB	No
FPGA Version	0270h	ENABLE LEADS OFF	Yes	DEFIB READY HOLD TIME	60 secs
CONFIGURATION	11.00	ASYNC SOFTKEY IN PACE	Yes	ENABLE REMOTE SYNC	No
ECG Core	0160h	CONFIG MODE PASSCODE	00000000		
PD Core	0100h	SUMMARY RESTART DELAY	90 Min		
DATE	16 DEC 11	CORRECTIVE VOICE PROMPTS	Yes		
TIME	14:43:00				
LAST CONFIG DATE	15 DEC 11				
DEVICE ID:	00000000 000				
LANGUAGE	English				
	5.50				

ADVISORY DEFIB/CPR OPTIONS (Page 1 of 2)		ADVISORY DEFIB/CPR OPTIONS (Page 2 of 2)	
SHOCK 1 ENERGY LEVEL	120 JOULES	DISPLAY DO CPR MESSAGE	Yes
SHOCK 2 ENERGY LEVEL	150 JOULES	CPR MSG. AFTER NO SHOCK ADV.	Perform CPR
SHOCK 3 ENERGY LEVEL	200 JOULES	CPR MSG. AFTER SHOCK	Perform CPR
PED. SHOCK 1 ENERGY LEVEL	50 JOULES	ENABLE CPR VOICE PROMPTS	Yes
PED. SHOCK 2 ENERGY LEVEL	70 JOULES	ENABLE CPR DISPLAY	Yes
PED. SHOCK 3 ENERGY LEVEL	85 JOULES	ENABLE CPR METRONOME	Yes
AUTO ANALYZE	Yes	CPR INTERVAL	2 Minutes
ENABLE CHECK PULSE PROMPT	No	DISPLAY FULLY RELEASE PROMPT	No
CHK PATIENT PROMPT	Check Patient	TARGET CPR DEPTH	2.0 inches
AUTO CHARGE WITH SHOCK ADV	Yes		
ENABLE VOICE PROMPTS	Yes		
STACKED SHOCKS	1		
RESTART ANALYSIS AFTER CPR	No		

MANUAL MODE FIXED OPTIONS		ALARM LIMITS AT POWER UP			ALARM LIMITS AT POWER UP				
DISPLAY LEAD	PADDLES/PADS		State	Low	High		State	Low	High
FREQUENCY RESPONSE	0.5 - 21 Hz	NIBP SYS	DISABLE	11.3	22.7	ECG HR	ENABLE	30	150
INITIAL QRS VOLUME	On	NIBP DIA	DISABLE	5.3	13.3	SpO2	ENABLE	85	100
GAIN ON POWER UP	1 cm/mV	NIBP MEAN	DISABLE	9.3	18.7	EtCO2	DISABLE	5.2	8.5
POWER UP PACE RATE	70	NIBP p SYS	DISABLE	11.3	20.7	RESP RATE	DISABLE	10	115
ENABLE PACER DETECTION	Yes	NIBP p DIA	DISABLE	2.7	14.7	ALARMS ACTIVE AT POWER UP			No
PRINT STRIPS	Yes	NIBP p MEAN	DISABLE	5.3	12.7				
PRINT 3 LEADS	No	NIBP n SYS	DISABLE	8.7	15.3				
TRACE 2 AT POWER UP	SpO2	NIBP n DIA	DISABLE	3.3	11.3				
TRACE 3 AT POWER UP	EtCO2	NIBP n MEAN	DISABLE	5.3	12.0				
SP02 AT POWER UP	Yes								



2C311

DISPLAY COLOR SELECTIONS		READINESS TEST OPTIONS	
ECG	Yellow	AUTOMATIC READINESS TEST	Once a Day
SpO2	Yellow	READINESS TEST TIME	12:00 A.M.
CPR	Yellow	PRINT READINESS TEST RESULTS	Yes
ETCO2	Cyan	ENABLE READINESS TEST ALERT	No
NIBP	Purple	ONE STEP PADZ INSTALLED	CPR/MWP/Complete

ZOLL Medical Corporation Reorder P/N: 8000-0300

ETCO2 SETTINGS		NIBP SETTINGS	
DEFAULT ETCO2 UNITS	%	BLOOD PRESSURE UNITS	kPa
DISPLAYED ETCO2 ZOOM LEVEL	0 - 13.3	TRIG NIBP MEAS ON BP ALARM	No
DEFAULT ETCO2 COMP SETTING	O2&N2O	TRIG NIBP MEAS ON HR ALARM	Yes
ETCO2 POWER SAVE MODE ENABLED	No	NIBP AUTO INTERVAL DEFAULT	60 Min
ETCO2 AVERAGE ON POWER UP	20 secs	NIBP ADULT 1ST INFLATE PRES.	34.7 kPa
		NIBP PED 1ST INFLATE PRES.	18.7 kPa
		NIBP NEO 1ST INFLATE PRES.	14.7 kPa
		NIBP PAT MODE AT POWER UP	Neonate
		NIBP BUTTON PRESS & HOLD	Auto
		ENABLE MOTION TOLERANCE	Yes

ZOLL Medical Corporation Reorder P/N: 8000-0300

WI-FI CONFIGURATION OPTIONS (Page 1 of 5)

Wi-Fi Region	US
DHCP/Static	DHCP
Local IP Address	0.0.0.0
Gateway IP Address	0.0.0.0
Subnet Mask	0.0.0.0
Use Host Name	No
DNS IP Address 1	0.0.0.0
DNS IP Address 2	0.0.0.0

2C311

WI-FI CONFIGURATION OPTIONS (Page 3 of 4)		WI-FI CONFIGURATION OPTIONS (Page 4 of 4)	
Defib History		Passphrase/Key 1	7777777777
Server Name	22223333	Passphrase/Key 2	
Server IP	0.144.0.0		
Server Port	9999		

ZOLL Medical Corporation Reorder P/N: 8000-0300

```
WI-FI CONFIGURATION OPTIONS (Page 4 of 5)
Network Profile 1

SSID
Security Key          tiamat
                    chromatic

Non-Broadcast SSID   No
Wi-Fi Authentication PSK
Authentication Protocol PEAP
User Identity

User Password

Private Key Password

Client Certificate    1.PFX

ZOLL Medical Corporation Reorder P/N: 8000-0300
```

```
WI-FI CONFIGURATION OPTIONS (Page 5 of 5)
Network Profile 2

SSID
Security Key          smaug
                    ancientred

Non-Broadcast SSID   No
Wi-Fi Authentication PSK
Authentication Protocol PEAP
User Identity

User Password

Private Key Password

Client Certificate    234567890.pfx

WI-FI DATA TRANSFER
Full Disclosure Transfer Mode Server
Defib History Transfer Mode None
Enable Report ID      No
Time Sync             Yes

ZOLL Medical Corporation Reorder P/N: 8000-0300
```



## Printing the Activity Log

In System Configuration mode, press the **Print** softkey, then the **Print Activity Log** softkey to print a stripchart of the unit's activity log. The log consists of the last 1,024 user entries or system prompts. See a copy of a sample Activity Log report below.

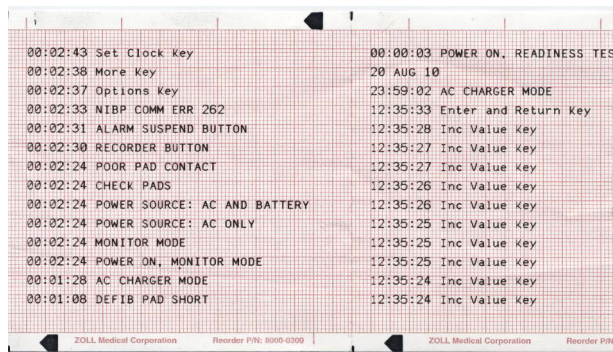
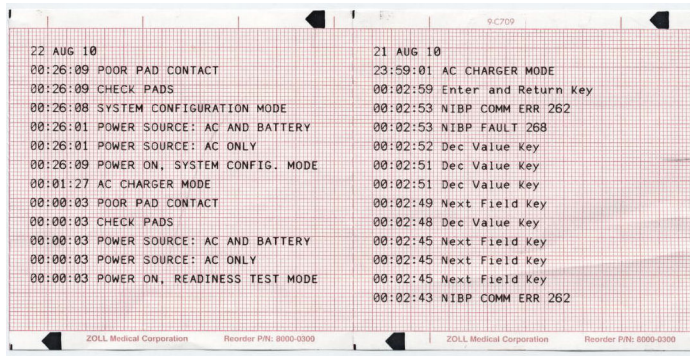
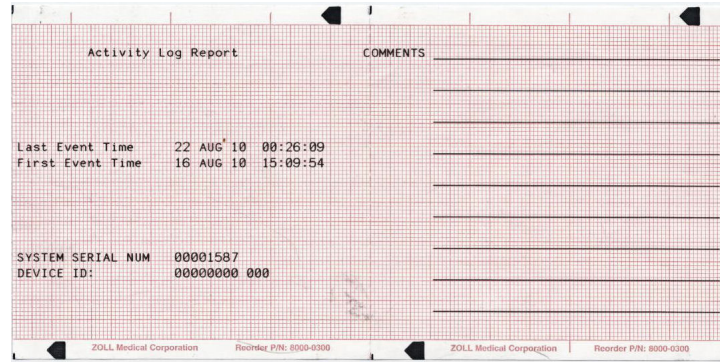

# Uploading Data from a Compact Flash Card

You can upload data from a compact flash card to perform the following tasks:

- Copy the configuration of one unit to any number of units
- Install new software to the unit
- Copy a second language to the unit

## Procedure

Follow these steps to load a configuration, another language, or software from a compact flash card:

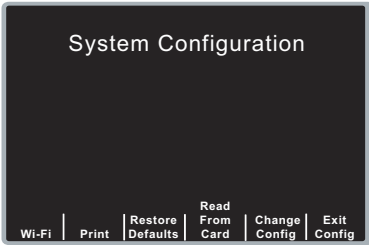
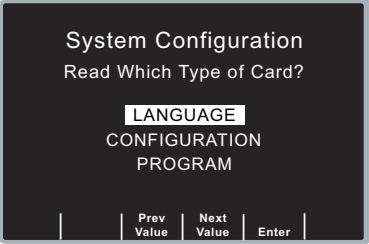
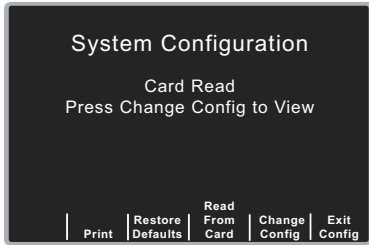
Step	Action
1.	<p>Install the compact flash card in the R Series unit, and power on the unit in System Configuration mode as described in "Entering System Configuration Mode" on page 2.</p> 
2.	<p>Press the <b>Read From Card</b> softkey to display the Read Card screen.</p> <p>Use the <b>Prev Value</b> and <b>Next Value</b> softkeys to toggle the highlighted area between the following options:</p> <ul style="list-style-type: none"> <li>• LANGUAGE - allows you to upload a second language to the unit. English is always on the unit as default, and one other language can be added.</li> <li>• CONFIGURATION -allows you to read the configuration data from a card, thereby configuring this unit.</li> <li>• PROGRAM - allows you to install new software in either the PD processor, ECG processor, or Wi-Fi Card.</li> </ul> <p><b>Note:</b> Do not install an older version of software over a newer version because it will cause software problems.</p> 
3.	<p>Press the <b>Enter</b> softkey to initiate reading and storing the information from the installed compact flash card.</p> <p>Once the card has been read and loaded, the unit displays the <i>CARD READ</i> message (for a language card) or the <i>CARD READ</i> and <i>PRESS CHANGE CONFIG TO VIEW</i> messages (for a configuration card).</p> 

If you want to review configuration settings, press the **Change Config** softkey. See "Accessing and Changing Configuration Settings" on page 11 for more information. If you want to leave

System Configuration mode, press the **Exit Config** softkey. See “Leaving Configuration Mode” on page 12 for more information.

If the unit encounters an error reading the memory card, one of the following error messages is displayed:

<b>Error Message</b>	<b>Description</b>
<i>CARD READ FAILED</i>	No response is detected from the card reader.
<i>BAD CARD</i>	The unit cannot read the card.
<i>NO CARD INSERTED</i>	The card is not installed in the data card slot.
<i>ECG VERSION ERROR</i>	ECG module software version less than or equal to 1.70 is detected.

## Saving Configuration to a Compact Flash Card

Whenever you exit configuration mode, you can optionally save the configuration to a compact flash card. This allows you to copy the configuration from one unit to any number of units.

### Procedure

Follow these steps to save configuration data to a compact flash card:

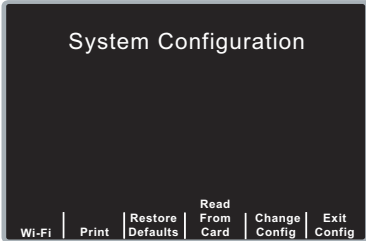
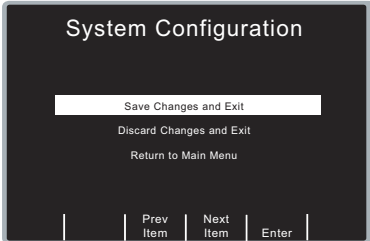
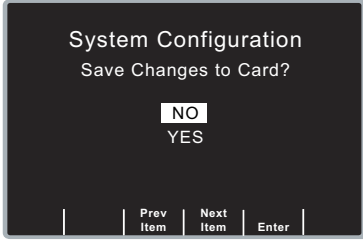
Step	Action	
1.	Power on the unit in System Configuration mode as described in "Entering System Configuration Mode" on page 2.	
2.	Press the <b>Exit Config</b> softkey to display the Exit Configuration screen, and then install the flash card in the R Series unit.	
3.	Press the <b>Enter</b> softkey to save the configuration changes and exit. The unit displays the SAVING CONFIGURATION and DO NOT POWER OFF messages and then the Save Changes To Card screen appears.	
4.	Press the <b>Next Item</b> softkey to highlight YES, then press the <b>Enter</b> softkey. The unit displays the SAVING TO CARD message and then the POWER OFF TO EXIT CONFIGURATION message.	

Note: Wi-Fi settings are not saved to a Compact Flash Card.

## Restoring Default Values

You can restore all configuration settings to their factory default settings. Only the display language, if different from the default, does not change.

### Procedure

Follow these steps to restore all configuration settings to default values:

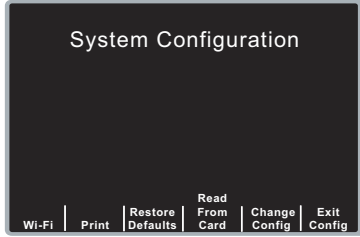
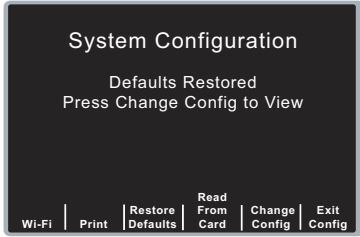
Step	Action
1.	<p>Power on the unit in System Configuration mode as described in “Entering System Configuration Mode” on page 2.</p> 
2.	<p>Press the <b>Restore Defaults</b> softkey to reconfigure settings to their default settings.</p> <p>Once default settings are restored, the unit displays the <i>DEFAULTS RESTORED</i> and <i>PRESS CHANGE CONFIG TO VIEW</i> messages.</p> 

If you want to review configuration settings, press the **Change Config** softkey. See “Accessing and Changing Configuration Settings” on page 11 for more information. If you want to leave System Configuration mode, press the **Exit Config** softkey. See “Leaving Configuration Mode” on page 12 for more information.



# Accessing and Changing Configuration Settings

You can change the current value for any configuration setting. You access most of the settings in the same way as described below. Additional steps are required to access and modify several settings. For those settings, the additional steps are provided with the setting description in the next chapter.

## Procedure

Follow these steps to access the settings.

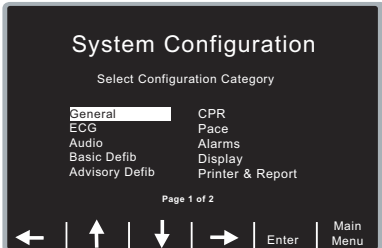
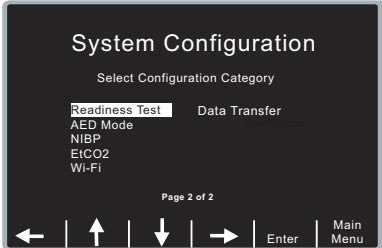
Step	Action
1.	<p>Press the <b>Change Config</b> softkey from the Main System Configuration screen. The unit advances to the Select Configuration Category screen.</p> <div style="display: flex; justify-content: space-between; align-items: center;">   </div>
2.	<p>Use the softkeys on the screen to move through the list and select a category, or to exit as follows:</p> <ul style="list-style-type: none"> <li>• <b>←↑↓→</b> — moves the highlight up, down, left, and right through the list of categories.</li> <li>• <b>Enter</b> — provides you access to the options of the highlighted category. Press this softkey once you have highlighted the appropriate category.</li> <li>• <b>Main Menu</b> — returns you to the Main System Configuration screen.</li> </ul>
3.	<p>Once you select and access the options for a category, you can highlight the specific setting you want to change, then press the <b>Change Value</b> softkey until the appropriate value is displayed.</p> <p><b>Note:</b> Some options require and evoke an additional screen to set the value (for example, setting the Device Identifier). Specific instructions for those options are provided in the next chapter.</p>

Step	Action
4.	When you are finished, you can either press the <b>Category List</b> softkey to return to the Category screen, or press the <b>Prev Item</b> or <b>Next Item</b> softkey to move to another option whose settings you want to modify.

## Leaving Configuration Mode

### Procedure

Follow the step below to leave System Configuration mode:

Step	Action
1.	<p>Press the <b>Exit Config</b> softkey from the Main System Configuration screen to display the Exit Configuration screen.</p> <p>Use the <b>Prev Item</b> and <b>Next Item</b> softkeys to toggle the highlighted area between the following options:</p> <ul style="list-style-type: none"> <li>• <b>SAVE CHANGES AND EXIT</b> saves all configuration changes you made and prompts you to Save to Card. If you specify Yes, the configuration information is saved to the installed Compact Flash card. Lastly, the message <i>POWER OFF TO EXIT CONFIG</i> is displayed. Power off the unit.</li> <li>• <b>DISCARD CHANGES AND EXIT</b>-disregards the changes you made and displays the message <i>POWER OFF TO EXIT CONFIG</i>. Power off the unit.</li> <li>• <b>RETURN TO MAIN MENU</b>- returns you to the Main System Configuration screen, where you can make more changes by selecting the <b>Change Config</b> softkey. You do not have to re-enter the passcode.</li> </ul> <p><b>Note:</b> No changes are made if you turn the unit off without saving the configuration.</p>

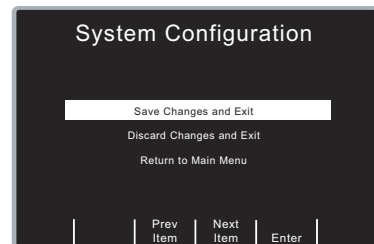

# Chapter 2

## Configuration Settings

---

This chapter describes all of the configuration settings on the R Series and includes the following sections.

- “General Settings” on page 14
- “ECG Settings” on page 19
- “Audio Settings” on page 22
- “Basic Defibrillation Settings” on page 24
- “Advisory Defib” on page 26
- “CPR Settings” on page 33
- “Pace Settings” on page 36
- “Alarms Settings” on page 37
- “Display Settings” on page 43
- “NIBP Settings (Optional)” on page 46
- “EtCO2 Settings (Optional)” on page 49
- “Printer & Report Settings” on page 51
- “Readiness Test Settings” on page 52
- “AED Mode” on page 54
- “Wi-Fi Settings (Optional)” on page 56
- “Data Transfer Settings (Optional)” on page 80

**Note:** The instructions in this chapter assume that you powered on the unit in System Configuration mode as described in “Entering System Configuration Mode” on page 2, and are familiar with how to access the settings, see “Accessing and Changing Configuration Settings” on page 11.

# General Settings

General settings are attributes that affect the unit’s basic operation and accessibility and include:

- Device Identifier
- Configuration Mode Passcode
- Code Markers

## Device Identifier

The Device Identifier feature allows you to set an 11-digit device identifier code for use with ZOLL software products. This code is divided into two sub codes: the site ID (consisting of eight alphanumeric characters) and the device ID (consisting of three alphanumeric characters). The device identifier is printed on the summary report and fax printouts.

**Note:** When configuration settings are imported from a Compact Flash card, the existing Device Identifier is not overwritten.

Values are as follows:

<b>Possible Values:</b>	0 through 9, A through Z, blank and underscore inclusive for each digit.
<b>Default:</b>	00000000 000

### Procedure

Follow these steps to set up a device identifier.

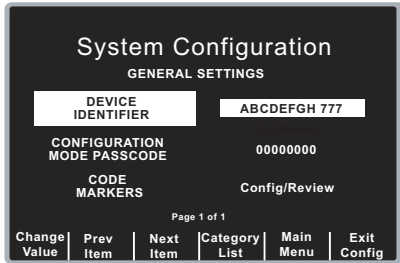
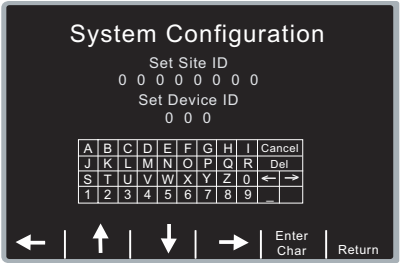
Step	Action
1.	<p>From the Select Configuration Categories screen, select General, then press the <b>Enter</b> softkey. The General Settings screen appears.</p> 
2.	<p>Select DEVICE IDENTIFIER and press the <b>Change Value</b> softkey. The Device Identifier screen appears.</p> 

Step	Action
3.	<p>In the character selection table:</p> <ul style="list-style-type: none"><li>• ←→ lets you move to the next or previous characters.</li></ul> <p>Use the softkeys as follows:</p> <ul style="list-style-type: none"><li>• ←↑↓→ — moves the highlight up, down, left, and right through the character selection table.</li><li>• <b>Enter Char</b> — enters the highlighted character for 8 digits of the Site ID and the 3 digits of the Device ID.</li><li>• <b>Return</b> — returns you to the General Settings screen. Press the <b>Return</b> softkey when you are finished entering the IDs. Note that selecting Enter also returns you to the General Settings screen.</li></ul>

## Configuration Mode Passcode

This feature allows you to set an 8-digit system configuration passcode. Once set, only those people who know the passcode can access the configuration mode and modify settings.

Values are as follows:

<b>Possible Values:</b>	0 through 3 inclusive for each digit
<b>Default:</b>	00000000

### Procedure

Follow these steps to set up a configuration mode passcode:

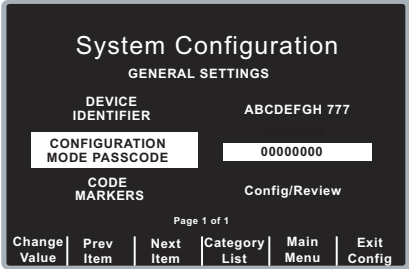
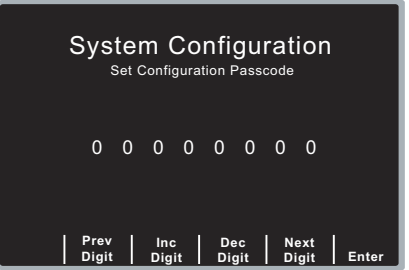
Step	Action
1.	<p>From the Select Configuration Categories screen, select General, then press the <b>Enter</b> softkey.</p> <p>The General Settings screen appears.</p> 
2.	<p>Select CONFIGURATION MODE PASSCODE and press the <b>Change Value</b> softkey.</p> <p>The Set Configuration Passcode screen appears.</p> 
3.	<p>Use the softkeys as follows:</p> <ul style="list-style-type: none"> <li>• <b>Prev Digit</b> — moves the highlight left to the previous digit.</li> <li>• <b>Inc Digit</b> or <b>Dec Digit</b> — increments or decrements the value of the selected digit.</li> <li>• <b>Next Digit</b> — moves the highlight right to the next digit to be entered.</li> <li>• <b>Enter</b> — saves the values that you entered and returns the unit to the General Configuration menu.</li> </ul>

## Code Markers

This setting allows you to review and change the preconfigured list of Code Markers for use in DEFIB, MONITOR, and PACE modes. Code Marker settings are language dependent. You can specify up to three groups (MONITOR, DEFIB, and PACE) of 20 entries each.

### Procedure

Follow these steps to review, change, or reset code marker settings:

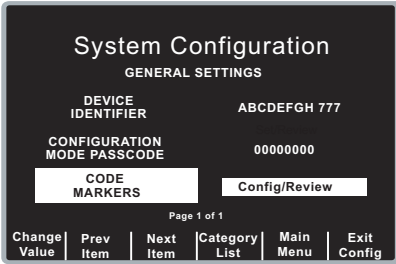
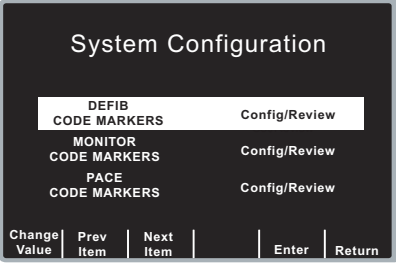
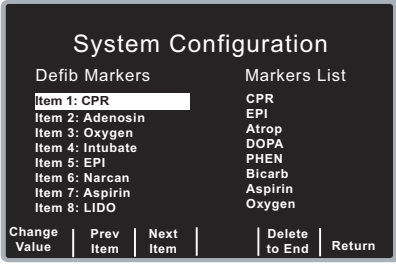
Step	Action
1.	<p>From the Select Configuration Categories screen, select General, then press the <b>Enter</b> softkey.</p> <p>The General Settings screen appears.</p> 
2.	<p>Select CODE MARKERS and press the <b>Change Value</b> softkey.</p> <p>The Select Code markers screen appears.</p> 
3.	<p>Select either DEFIB CODE MARKERS, MONITOR CODE MARKERS, or PACE CODE MARKERS, then press the <b>Change Value</b> softkey to toggle between Change/Review or Set to Defaults.</p> <ul style="list-style-type: none"> <li>If you select Set to Defaults, press the <b>Enter</b> softkey to set the chosen code markers to their default values.</li> <li>If you select Change/Review, press the <b>Enter</b> softkey to access the screen that allows you to change the marker, as shown.</li> </ul> <p><b>Note:</b> This example shows the screen that allows you to change DEFIB CODE MARKERS.</p> <p>Only 8 items are displayed on the screen at one time. When you get to the last item on the screen and press the <b>Next Item</b> softkey, you see the next 8 items. When you get to the last item on that screen and press the <b>Next Item</b> softkey, you see the remaining 4 items.</p> 

Step	Action
4.	<p>Use the softkeys as described to modify code marker items as needed:</p> <ul style="list-style-type: none"><li>• <b>Prev Item</b> and <b>Next Item</b> — scrolls the highlight to the next or previous code marker item.</li><li>• <b>Change Value</b> — allows you to pick a new marker for the selected item number. When you press the <b>Change Value</b> softkey, three new softkeys become available that allow you to highlight and select the code marker treatment for this item. They are:<ul style="list-style-type: none"><li>– <b>Prev Marker</b> and <b>Next Marker</b> — allow you to scroll through the Markers List and highlight the appropriate treatment.</li><li>– <b>Enter Marker</b> — set the highlighted treatment for this code marker item.</li></ul></li><li>• <b>Delete to End</b> — delete all configured markers from the highlighted item number to the end of the list. You can then enter new clinical actions for each item.</li><li>• <b>Return</b> — returns you to the previous menu.</li></ul>



## ECG Settings

ECG monitoring settings are attributes associated with using the R Series unit for ECG monitoring, and include:

- Notch Filter
- Display Lead on Power-Up
- Frequency Response
- ECG waveform size on Power Up
- Enable Leads Off
- Enable Pacer Detection
- Display ECG Scale

### Notch Filter

This setting allows you to select the ECG Notch Filter frequency for proper AC mains interference rejection.

Values are as follows:

<b>Possible Values:</b>	50 Hz, 60 Hz
<b>Default:</b>	60 Hz

### Display Lead on Power-Up

This setting allows you to select the lead to be displayed when you power on the unit.

Values are as follows:

<b>Possible Values:</b>	Paddles/Pads, Lead I, Lead II, Lead III
<b>Default:</b>	Paddles/Pads

### Frequency Response

This setting allows you to select the ECG filter bandwidth to be used during ECG monitoring. You can set the unit's frequency to either help reduce noise, help with the diagnostic response, or set it as a default response.

Values are as follows:

<b>Possible Values:</b>	0.5 - 21 Hz, 0.5 - 40 Hz, 1.0 - 21 Hz
<b>Default:</b>	0.5 - 21 Hz

## ECG waveform size on Power Up

This setting allows you to select the default size of the displayed ECG signal when you power on the unit.

Values are as follows:

<b>Possible Values:</b>	x0.5, x1, x1.5 and x2
<b>Default:</b>	x1 for Manual mode

**Note:** Size x1 corresponds to a gain of 1.0 cm/mV when only a single trace is displayed. See “Display ECG Scale” on page 21 for additional information.

## Enable Leads Off

This setting specifies whether the unit displays the *ECG LEADS OFF* message and a flat dashed ECG waveform when the unit detects that ECG leads do not have proper contact with the patient or the cable is not properly attached to the R Series unit. When set to No, the unit displays the *POOR LEAD CONTACT* message and the detected ECG signals when the cable or ECG leads are not properly attached to the patient or unit. When set to Yes, the unit displays the *ECG LEADS OFF* message and a flat dashed ECG waveform when the cable or ECG leads are not properly connected.

### Caution

Use care when interpreting ECG waveforms when the *POOR LEAD CONTACT* message displays; the ECG waveform may include a significant amount of artifact. Whenever possible, re-attach the leads before interpreting the waveform.

Values are as follows:

<b>Possible Values:</b>	Yes, No
<b>Default:</b>	Yes

**Note:** When in Pacer mode, the R Series unit functions as if this configuration is set to Yes.

## Enable Pacer Detection

This setting allows you to specify whether the unit should detect pacemaker signals from a patient with an implantable pacemaker and indicate those signals on the display. When you set this setting to Yes, a pacemaker marker is displayed on the ECG trace whenever the unit detects implanted pacer stimuli.

You can override this setting during normal operations. This setting simply indicates the default setting when you power on the unit.

Values are as follows:

<b>Possible Values:</b>	Yes, No
<b>Default:</b>	Yes

---

## Display ECG Scale

This setting, when set to Yes, results in the display of a 1-mV scale next to the leading edge of the ECG trace (Manual mode only).

Values are as follows:

<b>Possible Values:</b>	Yes, No
<b>Default:</b>	No

## Audio Settings

The Tone settings control audio functions on the R Series unit, and include:

- QRS Volume on Power-Up
- Low Battery Tone
- Enable Corrective Voice Prompts
- Voice Prompt Volume (1 = Min, 3 = Max)
- Silence Message Beeps

### QRS Volume on Power-Up

This setting allows you to select the default QRS beeper volume when you power on the unit. If you set this setting to Off, the unit does not beep during ECG monitoring.

Values are as follows:

<b>Possible Values:</b>	On, Off
<b>Default:</b>	On

### Low Battery Tone

This setting allows you to select the interval between Low Battery warning beeps. The Low Battery warning message is displayed once per minute, regardless of this setting.

Values are as follows:

<b>Possible Values:</b>	1 Min, 5 Min
<b>Default:</b>	5 Min

### Enable Corrective Voice Prompts

This setting allows you to specify whether voice prompts accompany the following corrective messages:

- Press Charge
- Select Defib Mode
- Remove Sync
- Release Shock
- Use Paddle Discharge

Values are as follows:

<b>Possible Values:</b>	Yes, No
<b>Default:</b>	Yes

**Note:** This setting is not available when the Standard Alarms factory option is not installed.

---

## Voice Prompt Volume (1 = Min, 3 = Max)

This setting allows you to select the volume of the voice prompts. It also controls the metronome volume if Metronome Tone (page 35) is set to Alternate 1 or Alternate 2.

<b>Possible Values:</b>	1, 2, 3
<b>Default:</b>	2

## Silence Message Beeps

This setting allows you to turn off the two quick beeps that occur when a message is displayed on the screen. This option has no effect on the beeps associated with the Low Battery message, as described above in the Low Battery Tone configuration setting.

Values are as follows:

<b>Possible Values:</b>	Yes, No
<b>Default:</b>	No

## Basic Defibrillation Settings

The Basic Defibrillation settings control functions related to performing defibrillation with the R Series unit in Manual mode and include:

- Defib Default to Pads
- Basic Auto Energy Escalation
- Retain Sync After Defib
- Defib Ready Hold Time
- Enable Remote Sync
- Highlight Sync On/Off Softkey

### Defib Default to Pads

This setting allows you to override the “Display Lead on Power-Up” setting and use Pads/Paddles whenever the unit is switched to DEFIB mode.

Values are as follows:

<b>Possible Values:</b>	Yes, No
<b>Default:</b>	Yes

### Basic Auto Energy Escalation

This setting allows you to configure the unit to automatically increment defibrillation energy to pre-specified levels after each of the first two shocks in Manual mode (see “Energy Level: Shock 1” on page 26, “Energy Level: Shock 2” on page 27, and “Energy Level: Shock 3” on page 27). When set to Yes, the *ENERGY INCREMENTED* message is displayed whenever the unit automatically increments the selected defibrillator energy after delivery of a shock with paddles or MFE pads.

**Note:** Manually changing the energy level outside the pre-programmed sequence and delivering a shock disables the auto energy escalation function until the unit is turned off for more than 10 seconds, then turned back on.

This option increments the energy level regardless of Shock Advisory activation or status.

Values are as follows:

<b>Possible Values:</b>	Yes, No
<b>Default:</b>	Yes

### Retain Sync After Defib

This setting allows you to configure the unit to remain in SYNC mode after a synchronized cardioversion shock. SYNC mode remains on until the **Sync On/Off** softkey is pressed again or the unit is switched out of DEFIB mode.

Values are as follows:

<b>Possible Values:</b>	Yes, No
<b>Default:</b>	No

## Defib Ready Hold Time

This setting allows you to specify the amount of time that the R Series unit will hold a charge before disarming.

Values are as follows:

<b>Possible Values:</b>	60 secs, 120 secs
<b>Default:</b>	60 secs

## Enable Remote Sync

This setting allows you to enable and disable the Remote Sync feature. If disabled (No), you can perform synchronized cardioversion using only the R Series ECG signal. If enabled (Yes), you can press the Sync On/Off softkey to select either Remote Sync or Sync.

Values are as follows:

<b>Possible Values:</b>	Yes, No
<b>Default:</b>	No

## Highlight Sync On/Off Softkey

This setting allows you to highlight the Sync On/Off softkey for easier visibility. If set to Yes, the softkey remains a highlighted color at all times.

Values are as follows:

<b>Possible Values:</b>	Yes, No
<b>Default:</b>	Yes

## Advisory Defib

The Advisory Defibrillation settings control functions related to performing defibrillation with an R Series unit in Advisory mode and include:

- Energy Level: Shock 1
- Energy Level: Shock 2
- Energy Level: Shock 3
- Ped Energy Level Shock 1
- Ped Energy Level Shock 2
- Ped Energy Level Shock 3
- Auto Analyze
- Enable Check Pulse Prompt
- Check Patient Prompt
- Auto Charge in Advisory Mode
- Enable Voice in Advisory Mode
- Display DO CPR Message
- CPR Message After No Shock Advised
- CPR Message After Shock
- Stacked Shocks
- Restart Analysis After CPR
- CPR Interval
- Stop CPR Prompt

### Energy Level: Shock 1

This setting allows you to select the energy level used for the first shock delivered by the defibrillator when the unit is:

- in AED mode or Advisory mode and using pads
- in Manual mode, using external paddles or pads

Energy Level: Shock 1 is the energy level to which the unit defaults when you power on the unit with external paddles or pads connected.

Values are as follows:

<b>Possible Values:</b>	<b>Adult:</b> 1-10, 15, 20, 30, 50, 75, 100, 120, 150, and 200 J
<b>Default:</b>	<b>Adult:</b> 120 J



## Energy Level: Shock 2

This setting allows you to select the energy level used for the second shock delivered by the defibrillator when the unit is:

- in AED mode or Advisory mode and using pads
- in Manual mode, using external paddles or pads, and Basic Auto Energy Escalation is set to Yes

Values are as follows:

<b>Possible Values:</b>	<b>Adult:</b> 1-10, 15, 20, 30, 50, 75, 100, 120, 150, and 200 J
<b>Default:</b>	<b>Adult:</b> 150 J

## Energy Level: Shock 3

This setting allows you to select the energy level used for the third and all subsequent shocks delivered by the defibrillator when the unit is:

- in AED mode or Advisory mode and using pads
- in Manual mode, using external paddles or pads, and Basic Auto Energy Escalation is set to Yes

Values are as follows:

<b>Possible Values:</b>	<b>Adult:</b> 1-10, 15, 20, 30, 50, 75, 100, 120, 150, and 200 J
<b>Default:</b>	<b>Adult:</b> 200 J

## Ped Energy Level Shock 1

This setting allows you to select the energy level used for the first pediatric shock delivered by the defibrillator when the unit is:

- in Advisory mode and using OneStep™ Pediatric electrodes.
- in Manual mode, using OneStep Pediatric electrodes

Ped Energy Level: Shock 1 is the energy level to which the unit defaults when you power on the unit with pediatric electrode pads.

Values are as follows:

<b>Possible Values:</b>	<b>Pediatric:</b> 1-10, 15, 20, 30, 50, 70, 85, 100, 120, 150, and 200 J
<b>Default:</b>	<b>Pediatric:</b> 50 J

---

**Warning!** The R Series will default to pediatric Shock 1, 2, and 3 energies only when ZOLL® OneStep pediatric electrodes are used. With pedi-padz® and pedi-padz II (or other non-ZOLL pediatric electrodes), you are required to manually set the selected energy to pediatric levels, per institutional protocols.

---

## Ped Energy Level Shock 2

This setting allows you to select the energy level used for the second pediatric shock delivered by the defibrillator when the unit is:

- in Advisory mode and using OneStep Pediatric electrodes.
- in Manual mode, using OneStep Pediatric electrodes and Basic Auto Energy Escalation is set to Yes

Values are as follows:

<b>Possible Values:</b>	<b>Pediatric:</b> 1-10, 15, 20, 30, 50, 70, 85, 100, 120, 150, and 200 J
<b>Default:</b>	<b>Pediatric:</b> 70 J

## Ped Energy Level Shock 3

This setting allows you to select the energy level used for the third and all subsequent shocks delivered by the defibrillator when the unit is:

- in Advisory mode and using OneStep Pediatric electrodes.
- in Manual mode, using OneStep Pediatric electrodes and Basic Auto Energy Escalation is set to Yes.

Values are as follows:

<b>Possible Values:</b>	<b>Pediatric:</b> 1-10, 15, 20, 30, 50, 70, 85, 100, 120, 150, and 200 J
<b>Default:</b>	<b>Pediatric:</b> 85 J

## Auto Analyze

This setting allows you to specify whether the unit automatically repeats ECG rhythm analyses after the delivery of shocks in Advisory mode and works in conjunction with the Stacked Shocks setting described on page 32. Enabling this setting also enables the occurrence of post-shock prompting to *DO CPR* and *PRESS ANALYZE*. When set to No, which is the Manual mode default, the unit does not perform analysis automatically (with the exception of Smart Alarms and the first analysis when you power on the unit in AED mode, if the unit is configured to analyze when you power on the unit).

When set to Yes and the Stacked Shocks options is set to 3, the unit automatically reanalyzes the patient's ECG rhythm after the first and second shocks in each three-shock sequence. Following delivery of the final shock, the unit stops automatic reanalysis and either displays a *CHECK PULSE* prompt, or immediately begins a CPR interval, depending on additional settings. This function operates only when the Auto Charge in Advisory Mode is set to Yes.

Values are as follows:

<b>Possible Values:</b>	Yes, No
<b>Default:</b>	Yes

## Enable Check Pulse Prompt

This setting works in conjunction with the Auto Analyze function and determines whether the unit displays the prompt *CHECK PULSE* for 10 seconds immediately after delivery of the final shock in a stacked shock sequence, after each No Shock Advised analysis result, or both. After *CHECK PULSE* clears, the CPR interval begins.

When set to No, the unit immediately begins the CPR interval following delivery of the final shock or after each No Shock Advised analysis result.

Values are as follows:

<b>Possible Values:</b>	Yes, No, After No Shock Only, After Shock Only
<b>Default:</b>	No

## Check Patient Prompt

This setting allows you to change the display message and the voice prompt issued when a shockable rhythm has been detected by background ECG analysis and Heart Rate Alarms are enabled.

Values are as follows:

<b>Possible Values:</b>	<i>CHECK PATIENT, PRESS ANALYZE</i>
<b>Default:</b>	<i>CHECK PATIENT</i>

## Auto Charge in Advisory Mode

This setting allows you to specify whether the unit automatically charges the defibrillator to the configured or user-selected energy setting after detection of a shockable rhythm by ECG analysis. When set to Yes, the unit automatically charges the defibrillator to the configured or user-selected energy setting. When set to No, it does not.

Values are as follows:

<b>Possible Values:</b>	Yes, No
<b>Default:</b>	Yes

## Enable Voice in Advisory Mode

This setting allows you to enable or disable voice prompts when using shock advisory functions (ECG analysis) in Manual mode. If enabled, the voice prompts sound at the appropriate time. If disabled, the unit emits two beeps instead of the voice prompts in Manual mode.

Voice prompts are in the language specified by the Language option.

Values are as follows:

<b>Possible Values:</b>	Yes/No
<b>Default:</b>	Yes

## Display DO CPR Message

This setting allows you to specify whether the unit displays the configured CPR prompt (described in CPR Text Message) for the configured CPR time interval after each set of stacked shocks, even if a perfusing rhythm is present. The unit behaves differently depending on this particular setting value.

**Note:** This setting is always set to Yes in AED mode.

- When set to No (the Manual mode default), the unit behaves as follows:
  - At the end of any analysis with an outcome of no shock advised, the unit displays the *NO SHOCK ADVISED* message. The unit then remains idle for the configured CPR interval duration. After the CPR interval, if the **ANALYZE** softkey has not been pressed, the *PRESS ANALYZE* message is displayed and remains until a new analysis is started or the mode is changed.
  - At the end of a stacked shock sequence (assuming the final shock is delivered) and when the optional 10 second *CHECK PULSE* message disappears, the CPR interval begins. The unit remains idle for the duration of the CPR interval. After the CPR interval, if the **ANALYZE** softkey has not been pressed, the *PRESS ANALYZE* prompt is displayed and remains until a new analysis is started or the mode is changed.
  - If the defibrillator disarms itself after it was charged (because the Defib Ready time elapsed before a shock was delivered), the unit displays the *PRESS ANALYZE* prompt until the **ANALYZE** softkey is pressed.
- When set to Yes, the unit behaves as follows:
  - At the end of any analysis with an outcome of no shock advised, the unit displays the *NO SHOCK ADVISED* message for 10 seconds, after which the message is cleared and the configured CPR prompt is displayed for the duration of the CPR interval. After the CPR interval, the *PRESS ANALYZE* prompt is displayed until a new analysis is started or a mode change occurs. You can start a new analysis during the CPR interval by pressing the **ANALYZE** softkey.
  - At the end of a stacked shock sequence (assuming the final shock is delivered) and when the optional 10 second *CHECK PULSE* message disappears, the CPR interval begins. The configured CPR prompt is displayed for the duration of the CPR interval. After the CPR interval, the CPR prompt is cleared and a new analysis starts automatically.

- If the defibrillator disarms itself after it was charged (because the Defib Ready time elapsed before a shock was delivered), the unit displays the *PRESS ANALYZE* prompt until the **ANALYZE** softkey is pressed.

**Note:** The Display DO CPR Message feature is operational only when the Auto Charge in Advisory Mode and Auto Analyze options are both set to Yes.

Values are as follows:

<b>Possible Values:</b>	Yes, No
<b>Default:</b>	Yes

## CPR Message After No Shock Advised

This parameter determines which CPR message/voice prompt is issued during the CPR interval after a No Shock Advised analysis result. The selected message is displayed throughout the entire CPR interval.

Values are as follows:

<b>Possible Values:</b>	"If No Pulse, Perform CPR", "Perform CPR"
<b>Default:</b>	Perform CPR

## CPR Message After Shock

This parameter determines which CPR message/voice prompt is issued during the CPR interval after the delivery of the final shock in a stacked shock sequence. The selected message is displayed throughout the entire CPR interval.

Values are as follows:

<b>Possible Values:</b>	"If No Pulse, Perform CPR", "Perform CPR"
<b>Default:</b>	"Perform CPR"

## Stacked Shocks

The setting specifies the number of stacked shocks that must be administered prior to the activation of a CPR interval and works in conjunction with the Auto Analyze setting. If set to 3, the unit will auto analyze 3 times before prompting the user. If set to 1, the unit will auto analyze once.

Values are as follows:

<b>Possible Values:</b>	1, 3
<b>Default:</b>	1

## Restart Analysis After CPR

When this parameter is set to Yes, the analysis starts automatically after the CPR interval following each stacked shock sequence. Analyses do not automatically restart after a CPR interval following No Shock Advised results. When this parameter is set to No, the PRESS ANALYZE message is displayed, but the analysis does not restart.

**Note:** This setting is always set to Yes in AED mode.

Values are as follows:

<b>Possible Values:</b>	Yes, No
<b>Default:</b>	No

## CPR Interval

This setting allows you to specify the duration of the CPR interval as described in the Display DO CPR Message setting. Values are as follows:

<b>Possible Values:</b>	1, 1.5, 2, 2.5, 3, 3.5, or 4 minutes
<b>Default:</b>	2 minutes

## Stop CPR Prompt

This setting allows you to display the Stop CPR prompt 3 seconds before the end of the CPR interval. Values are as follows:

<b>Possible Values:</b>	None, AED Only, Manual Only, Both AED and Manual
<b>Default:</b>	None

## CPR Settings

The CPR settings control functions related to Real CPR Help<sup>®</sup> function:

- Enable CPR Voice Prompts
- Enable CPR Display
- Enable CPR Dashboard
- Display Release Bar
- Enable CPR Metronome
- Target CPR Depth
- CPR Depth Units
- Display Fully Release Prompt
- Display Filtered ECG as Top Trace
- Metronome Tone

### Enable CPR Voice Prompts

This setting allows you to enable (Yes) or disable (No) voice prompts during CPR. Voice prompts are in the language specified by the Language option.

**Note:** This setting is always set to Yes in AED mode.

Values are as follows:

<b>Possible Values:</b>	Yes, No
<b>Default:</b>	Yes

### Enable CPR Display

This setting allows you to enable (Yes) or disable (No) the display of the CPR indicator on the monitor.

Values are as follows:

<b>Possible Values:</b>	Yes, No
<b>Default:</b>	Yes

### Enable CPR Dashboard

If Enable CPR Display is set to Yes, this setting allows you to enable (Yes) or disable (No) the display of the CPR Dashboard<sup>™</sup> at the top of the screen. The CPR Dashboard consists of the CPR Rate and Depth numeric values, the optional Compression Release Bar, and the Perfusion Performance Indicator<sup>™</sup>.

<b>Possible Values:</b>	Yes, No
<b>Default:</b>	Yes

## Display Release Bar

If Enable CPR Dashboard is set to Yes, this setting allows you to enable (Yes) or disable (No) the display of the Compression Release Bar in the CPR Dashboard.

<b>Possible Values:</b>	Yes, No
<b>Default:</b>	Yes

## Enable CPR Metronome

This setting allows to you to configure the audible CPR metronome in Manual mode. When set to No, the metronome is off. When set to Yes, the metronome only beeps when chest compressions are detected and their rate falls below the AHA/ERC recommended levels. When set to Continuous, the metronome beeps as long as compressions are detected, regardless of the compression rate.

In AED mode, this setting is always set to Continuous.

Values are as follows:

<b>Possible Values:</b>	Yes, No, Continuous
<b>Default:</b>	Yes

## Target CPR Depth

This parameter allows you to select the minimum compression depth required for Good Compressions: 1.5 inches (3.8 cm), 1.6 (4.0 cm), or 2.0 inches (5.0 cm), based on your local protocol. If this parameter is set to 1.5 inches, the reference markers on the CPR bar graph are displayed at 1.5 and 2.0 inches. If this parameter is set to 1.6 inches, the reference markers on the CPR bar graph are displayed at 1.6 and 2.4 inches. If this parameter is set to 2.0 inches, the reference markers on the CPR bar graph are displayed at 2.0 and 2.4 inches.

Values are as follows:

<b>Possible Values:</b>	1.5 inches, 1.6 inches, 2.0 inches
<b>Default:</b>	2.0 inches

## CPR Depth Units

This setting allows you to display the numeric depth value in inches (in) or centimeters (cm).

Values are as follows:

<b>Possible Values:</b>	in, cm
<b>Default:</b>	in



## Display Fully Release Prompt

This parameter, when set to Yes, specifies that the *FULLY RELEASE* prompt will be displayed every 45 seconds during CPR. If this parameter is set to No, the prompt is not displayed.

Values are as follows:

<b>Possible Values:</b>	Yes, No
<b>Default:</b>	No

## Display Filtered ECG as Top Trace

If Display CPR Dashboard is set to Yes, this setting allows you to display the See-Thru CPR<sup>®</sup> filtered waveform on the top trace.

<b>Possible Values:</b>	Yes, No
<b>Default:</b>	No

## Metronome Tone

This parameter allows you to set the volume of the metronome tone. If set to Standard, the tone emits through the unit's beeper (softer). If set to Alternate 1, the tone emits through the unit's speaker (louder). If set to Alternate 2, the tone uses a traditional metronome sound through the speaker (louder).

<b>Possible Values:</b>	Standard, Alternate 1, Alternate 2
<b>Default:</b>	Standard

## Pace Settings

The Pace settings are attributes that control functions related to performing pacing with an R Series unit and include:

- Pace Rate Setting on Power-Up
- Async (Fixed) Softkey in Pace Mode
- Async or Fixed Pace Labels

### Pace Rate Setting on Power-Up

This setting allows you to set the default pace rate, pulses per minute (ppm), of the R Series when you power on the unit.

Values are as follows:

<b>Possible Values:</b>	30 ppm to 102 ppm (inclusive in increments of 4 ppm)
<b>Default:</b>	70 ppm

### Async (Fixed) Softkey in Pace Mode

This setting allows you to set the unit to display the **Async (Fixed) Pacing On/Off** softkey when the unit is in Pace mode. For information about Asynchronous Pacing, refer to the *R Series Operator's Guide*.

Values are as follows:

<b>Possible Values:</b>	Yes, No
<b>Default:</b>	Yes

### Async or Fixed Pace Labels

This setting allows you to change the wording of the Async pacing softkey and messages when the unit is in Pace mode and Async Softkey in Pace Mode is set to Yes. If set to Async, the softkey displays **Async Pacing On/Off** and the message area displays *ASYNC PACE* or *PACE*. If set to Fixed, the softkey displays **Fixed Pacing On/Off** and the message area displays *FIXED PACE* or *DEMAND PACE*.

Values are as follows:

<b>Possible Values:</b>	Async, Fixed
<b>Default:</b>	Async

## Alarms Settings

Alarm settings are attributes associated with Alarm states and thresholds for the R Series unit and include:

- Alarm Limits at Power Up
- Alarms Active at Power Up

## Alarm Limits at Power Up

This option allows you to enable or disable, and set high and low threshold values for the ECG Heart Rate, and the SpO<sub>2</sub> alarms on the R Series unit. All alarms listed below (Heart Rate and optional devices SpO<sub>2</sub>, EtCO<sub>2</sub>, NIBP) are enabled by default. Values are as follows:

<b>Possible Values:</b>	<p><b>Heart Rate:</b></p> <p><b>High:</b> 60 - 280 beats per minute (BPM) inclusive in 5 BPM increments</p> <p><b>Low:</b> 20 - 100 beats per minute (BPM) inclusive in 5 BPM increments</p> <p><b>Optional Devices:</b></p> <p><b>SpO<sub>2</sub>:</b></p> <p><b>High:</b> 72-100% in 1% increments</p> <p><b>Low:</b> 70-98% in 1% increments</p> <p><b>EtCO<sub>2</sub>:</b></p> <p><b>High:</b> 5-100 mmHg in increments of 5 0.6-13.3 kPa in increments of .67 0.6-13.1% in increments of .66</p> <p><b>Low:</b> 0-95 mmHg in increments of 5 0.0-12.6 kPa in increments of .67 0-12.5% in increments of 0.66</p> <p><b>Resp Rate:</b></p> <p><b>High:</b> 5-150 breaths per minute in increments of 5</p> <p><b>Low:</b> 0-100 breaths per minute in increments of 5</p> <p><b>NIBP Sys:</b></p> <p><b>Adult:</b></p> <p><b>High:</b> 80-260 mmHg in increments of 5 10.7-34.7 kPa in increments of 0.67</p> <p><b>Low:</b> 40-140 mmHg in increments of 5 5.3-18.7 kPa in increments of 0.67</p> <p><b>Pediatric:</b></p> <p><b>High:</b> 80-160 mmHg in increments of 5 10.7-21.3 kPa in increments of 0.67</p> <p><b>Low:</b> 35-140 mmHg in increments of 5 4.7-18.7 kPa in increments of 0.67</p> <p><b>Neonatal:</b></p> <p><b>High:</b> 60-130 mmHg in increments of 5 8.0-17.3 kPa in increments of 0.67</p> <p><b>Low:</b> 25-120 mmHg in increments of 5 3.3-16.0 kPa in increments of 0.67</p>
-------------------------	---------------------------------------------------------------------------------------------------------------------------------------------------------------------------------------------------------------------------------------------------------------------------------------------------------------------------------------------------------------------------------------------------------------------------------------------------------------------------------------------------------------------------------------------------------------------------------------------------------------------------------------------------------------------------------------------------------------------------------------------------------------------------------------------------------------------------------------------------------------------------------------------------------------------------------------------------------------------------------------------------------------------------------------------------------------------------------------------------------------------------------------------------------------------------------------------------------------------------------------------------------------------------------------------------------------------------------------------------------------------------------------------------------------------------------------------------------

<b>Possible Values:</b>	<b>NIBP Dia:</b> <b>Adult:</b> <b>High:</b> 50-200 mmHg in increments of 5 6.7-26.7 kPa in increments of 0.67 <b>Low:</b> 25-100 mmHg in increments of 5 3.3-13.3 kPa in increments of 0.67  <b>Pediatric:</b> <b>High:</b> 50-130 mmHg in increments of 5 6.7-17.3 kPa in increments of 0.67 <b>Low:</b> 20-100 mmHg in increments of 5 2.7-13.3 kPa in increments of 0.67  <b>Neonatal:</b> <b>High:</b> 30-105 mmHg in increments of 5 4.0-14.0 kPa in increments of 0.67 <b>Low:</b> 20-100 mmHg in increments of 5 2.7-13.3 kPa in increments of 0.67  <b>NIBP Mean:</b> <b>Adult:</b> <b>High:</b> 60-220 mmHg in increments of 5 8.0-29.3 kPa in increments of 0.67 <b>Low:</b> 30-120 mmHg in increments of 5 4.0-16.0 kPa in increments of 0.67  <b>Pediatric:</b> <b>High:</b> 60-140 mmHg in increments of 5 8.0-18.7 kPa in increments of 0.67 <b>Low:</b> 30-120 mmHg in increments of 5 4.0-16.0 kPa in increments of 0.67  <b>Neonatal:</b> <b>High:</b> 35-110 mmHg in increments of 5 4.7-14.7 kPa in increments of 0.67 <b>Low:</b> 30-105 mmHg in increments of 5 4.0-14.0 kPa in increments of 0.67
-------------------------	-------------------------------------------------------------------------------------------------------------------------------------------------------------------------------------------------------------------------------------------------------------------------------------------------------------------------------------------------------------------------------------------------------------------------------------------------------------------------------------------------------------------------------------------------------------------------------------------------------------------------------------------------------------------------------------------------------------------------------------------------------------------------------------------------------------------------------------------------------------------------------------------------------------------------------------------------------------------------------------------------------------------------------------------------------------------------------------------------------------------------------------------------------------------------------------------------------------------------------------

<b>Default:</b>	<b>Heart Rate:</b> <b>High:</b> 150 BPM <b>Low:</b> 30 BPM  <b>Optional Devices:</b>  <b>SpO<sub>2</sub>:</b> <b>High:</b> 100% <b>Low:</b> 85% <b>EtCO<sub>2</sub>:</b> <b>High:</b> 55 mmHg 7.3 kPa 7.2% <b>Low:</b> 25 mmHg 3.3 kPa 3.2% <b>Resp Rate:</b> <b>High:</b> 120 <b>Low:</b> 5  <b>NIBP Sys:</b> <b>Adult:</b> <b>High:</b> 160 mmHg 21.3 kPa <b>Low:</b> 90 mmHg 12.0 kPa  <b>Pediatric:</b> <b>High:</b> 145 mmHg 19.3 kPa <b>Low:</b> 75 mmHg 10.0 kPa  <b>Neonatal:</b> <b>High:</b> 100 mmHg 13.3 kPa <b>Low:</b> 50 mmHg 6.7 kPa
-----------------	---------------------------------------------------------------------------------------------------------------------------------------------------------------------------------------------------------------------------------------------------------------------------------------------------------------------------------------------------------------------------------------------------------------------------------------------------------------------------------------------------------------------------------------------------------------------------------------------------------------------------------------------------------------------

<b>Default</b>	<b>NIBP Dia:</b> <b>Adult:</b> <b>High:</b> 110 mmHg 14.7 kPa <b>Low:</b> 50 mmHg 6.7 kPa  <b>Pediatric:</b> <b>High:</b> 100 mmHg 13.3 kPa <b>Low:</b> 35 mmHg 4.7 kPa  <b>Neonatal:</b> <b>High:</b> 70 mmHg 9.3 kPa <b>Low:</b> 30 mmHg 4.0 kPa  <b>NIBP Mean:</b> <b>Adult:</b> <b>High:</b> 130 mmHg 17.3 kPa <b>Low:</b> 60 mmHg 8.0 kPa  <b>Pediatric:</b> <b>High:</b> 110 mmHg 14.7 kPa <b>Low:</b> 50 mmHg 6.7 kPa  <b>Neonatal:</b> <b>High:</b> 80 mmHg 10.7 kPa <b>Low:</b> 35 mmHg 4.7 kPa
----------------	----------------------------------------------------------------------------------------------------------------------------------------------------------------------------------------------------------------------------------------------------------------------------------------------------------------------------------------------------------------------------------------------------------------------------------------------------------------------------------------------------------------------------------------------------------------------------------------------------------------------

### Procedure

Follow these steps to change the state or value of the ECG Heart Rate alarms:

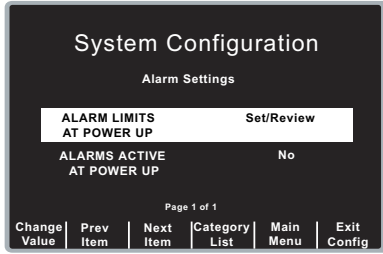
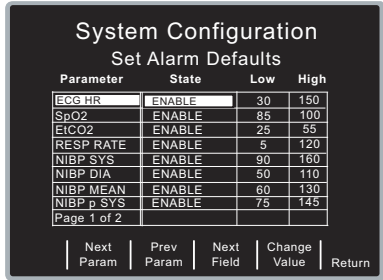
Step	Action
1.	<p>From the Select Configuration Categories screen, select Alarms, then press the <b>Enter</b> softkey. The Alarms Setting screen appears.</p> 
2.	<p>Select Alarm Limits at Power Up, and press the <b>Change Value</b> softkey. The Set Alarm Defaults screen appears.</p> 
3.	<p>Modify alarms using the softkeys as follows:</p> <ul style="list-style-type: none"> <li>• <b>Next Param</b> and <b>Prev Param</b> — moves the highlight through the various physiological settings.</li> <li>• <b>Next Field</b> — moves highlight to the next field to the right. Use this key to change the High and Low settings.</li> <li>• <b>Change Value</b> — allows you to change the value of the highlighted field. When you press this softkey, the following softkeys become available: <ul style="list-style-type: none"> <li>– <b>Inc &gt;</b> and <b>Dec &lt;</b> — increases and decreases the value of the field.</li> <li>– <b>Enter</b> — applies the value you specified for this field.</li> <li>– <b>Cancel</b> — returns you to the previous screen without applying any changes.</li> </ul> </li> <li>• <b>Return</b> — enters the values you specified, and returns you to the previous screen.</li> </ul>

### Alarms Active at Power Up

This setting allows you to specify whether alarms are automatically active when you power on the unit. This setting applies to all alarms enabled by the Alarm Limits At Power Up setting.



Values are as follows:

<b>Possible Values:</b>	Yes, No
<b>Default:</b>	No

## Display Settings

The Display settings are attributes that control what and how things appear on the R Series monitor and include:

- Display Time
- Select Trace 2 At Power Up
- Select Trace 3 At Power Up
- ECG Color
- SpO2 Color
- CPR Color
- EtCO2 Color
- NIBP Color
- SPO2 at Power Up
- Display Shock Count in Manual Mode

### Display Time

This setting specifies whether to display the elapsed time since the unit was turned on (Elapsed Time), or the real time (Real Time), or not to display the time (Off).

The elapsed time continues to be counted for up to 10 seconds after you power off the unit. This gives the operator adequate time to change the battery without resetting the elapsed timer.

Elapsed time is reset to zero (00:00) whenever the unit has been off for more than 10 seconds.

Values are as follows:

<b>Possible Values:</b>	Real Time, Off, Elapsed Time
<b>Default:</b>	Elapsed Time

### Select Trace 2 At Power Up

This setting allows you to set which waveform will appear in the Trace 2 position on the display when you turn on the R Series unit.

Values are as follows:

<b>Possible Values:</b>	Off, 3 Lead ECG, CPR, Filtered ECG, SpO2, EtCO2
<b>Default:</b>	Filtered ECG

**Note:** When you set this setting to 3 Lead ECG, the Select Trace 3 At Power Up setting automatically defaults to 3 Lead ECG.

## Select Trace 3 At Power Up

This setting allows you to select which waveform will appear in the Trace 3 position on the display when you turn on the R Series unit.

Values are as follows:

<b>Possible Values:</b>	Off, 3 Lead ECG, CPR, Filtered ECG, SpO <sub>2</sub> , EtCO <sub>2</sub>
<b>Default:</b>	Off

**Note:** When you select 3 Lead ECG, the Select Trace 2 At Power Up setting automatically defaults to 3 Lead ECG.

## ECG Color

This setting allows you to set the display color for the ECG waveform and information displayed on the R Series monitor.

Values are as follows:

<b>Possible Values:</b>	Red, Cyan, Purple, Blue, Green, Yellow, White
<b>Default:</b>	Green

## SpO<sub>2</sub> Color

This setting allows you to specify the color of the SpO<sub>2</sub> information displayed (if installed) on the R Series monitor.

Values are as follows:

<b>Possible Values:</b>	Cyan, Red, Purple, Yellow, White, Blue, Green
<b>Default:</b>	Cyan

## CPR Color

This setting allows you to specify the color of the CPR indicator and waveform on the R Series monitor.

Values are as follows:

<b>Possible Values:</b>	Red, Cyan, Purple, Blue, Green, Yellow, White
<b>Default:</b>	Purple

## EtCO<sub>2</sub> Color

This setting allows you to specify the color of the CO<sub>2</sub> indicator and waveform (if installed) on the R Series monitor. Values are as follows:

<b>Possible Values:</b>	Blue, Green, Cyan, Red, Purple, Yellow, White
<b>Default:</b>	Yellow

## NIBP Color

This setting allows you to specify the color of the NIBP indicator (if installed) on the R Series monitor. Values are as follows:

<b>Possible Values:</b>	White, Blue, Green, Cyan, Red, Purple, Yellow
<b>Default:</b>	White

## SPO<sub>2</sub> at Power Up

This setting allows you to control whether the SPO<sub>2</sub> box appears on the R Series monitor (if installed). If set to Yes, the box will be displayed regardless of whether the SPO<sub>2</sub> sensor is connected to the unit. If set to No, the box will not appear until the sensor is connected to the unit. Values are as follows:

<b>Possible Values:</b>	Yes, No
<b>Default:</b>	Yes

## Display Shock Count in Manual Mode

This setting allows you to display the number of shocks delivered while in Manual mode.

<b>Possible Values:</b>	Yes, No
<b>Default:</b>	No

## NIBP Settings (Optional)

NIBP configuration parameters are available for update only if the NIBP monitoring option is installed on the unit, and include:

- Blood Pressure Units
- Trigger NIBP Meas on BP Alarm
- Trigger NIBP Meas on HR Alarm
- NIBP Auto Interval Default
- Adult Initial Cuff Inflation
- Pediatric Initial Cuff Inflation
- Neonatal Initial Cuff Inflation
- NIBP Patient Mode at Power Up
- NIBP Button Press & Hold
- Enable Motion Tolerance

### Blood Pressure Units

This parameter allows you to set the NIBP unit of measurement.

Values are as follows:

<b>Possible Values:</b>	mmHg (millimeters of mercury), kPa (kilopascals)
<b>Default:</b>	mmHg

### Trigger NIBP Meas on BP Alarm

This parameter allows you to specify whether or not the R Series unit initiates a single additional blood pressure measurement when any of the NIBP alarms trigger.

Values are as follows:

<b>Possible Values:</b>	Yes, No
<b>Default:</b>	Yes

### Trigger NIBP Meas on HR Alarm

This parameter allows you to specify whether or not the R Series unit initiates a single blood pressure measurement when the heart rate/pulse rate alarm triggers.

Values are as follows:

<b>Possible Values:</b>	Yes, No
<b>Default:</b>	No

## NIBP Auto Interval Default

This parameter allows you to set the default for the amount of time between automatic measurements.

Values are as follows:

<b>Possible Values:</b>	2.5, 3, 4, 5, 6, 7, 8, 9, 10, 15, 20, 30, 45, 60, 90, 120 minutes
<b>Default:</b>	5 minutes

## Adult Initial Cuff Inflation

This parameter allows you to set the default NIBP cuff inflation pressure (the pressure to which the NIBP cuff inflates at the beginning of its first measurement after power up).

Values are as follows:

<b>Possible Values:</b>	mmHg: 120, 140, 160, 180, 200, 220, 240, 260 kPa: 16.0, 18.7, 21.3, 24.0, 26.7, 29.3, 32.0, 34.7
<b>Default:</b>	mmHg: 160 kPa: 21.3

## Pediatric Initial Cuff Inflation

This parameter allows you to set the default pediatric NIBP cuff inflation pressure (the pressure to which the NIBP cuff inflates at the beginning of its first measurement after power up, if set to pediatric).

Values are as follows:

<b>Possible Values:</b>	mmHg: 80, 90, 100, 110, 120, 130, 140, 150 kPa: 10.7, 12.0, 13.3, 14.7, 16.0, 17.3, 18.7, 20.0
<b>Default:</b>	mmHg: 120 kPa: 16.0

## Neonatal Initial Cuff Inflation

This parameter allows you to set the default NIBP cuff inflation pressure (the pressure to which the NIBP cuff inflates at the beginning of its first measurement after power up, if set to neonatal).

Values are as follows:

<b>Possible Values:</b>	mmHg: 60, 70, 80, 90, 100, 110, 120, 130 kPa: 8.0, 9.3, 10.7, 12.0, 13.3, 14.7, 16.0, 17.3
<b>Default:</b>	mmHg: 90 kPa: 12.0

## NIBP Patient Mode at Power Up

This parameter allows you to set the default patient mode at power up.

Values are as follows:

<b>Possible Values:</b>	Adult, Pediatric, Neonate
<b>Default:</b>	Adult

## NIBP Button Press & Hold

This parameter allows you to define which NIBP function is activated when the front panel NIBP button () is pressed and held for at least 2 seconds. You can configure the unit to either:

- Begin a sequence of STAT measurements, or
- Begin taking NIBP measurements at repeating, selected intervals.

Values are as follows:

<b>Possible Values:</b>	Stat, Auto
<b>Default:</b>	Auto

## Enable Motion Tolerance

This parameter allows you enable compensation for motion tolerance, such as on a moving stretcher.

Values are as follows:

<b>Possible Values:</b>	Yes, No
<b>Default:</b>	Yes

## EtCO<sub>2</sub> Settings (Optional)

EtCO<sub>2</sub> configuration parameters are available for update only if the EtCO<sub>2</sub> monitoring option is installed on the unit and include:

- Default EtCO<sub>2</sub> Units
- Displayed Zoom Level
- Default EtCO<sub>2</sub> Comp Setting
- Power Save Mode at Power Up
- EtCO<sub>2</sub> Average On Power Up

### Default EtCO<sub>2</sub> Units

This parameter allows you to set the EtCO<sub>2</sub> unit of measurement.

Values are as follows:

<b>Possible Values:</b>	mmHg (millimeters of mercury), kPa (kilopascals), % (percent)
<b>Default:</b>	mmHg

### Displayed Zoom Level

This parameter allows you to set the default scale setting for the displayed capnographic waveform. It does not affect the printed waveform or the waveform data stored on the data card.

Values are as follows:

<b>Possible Values:</b>	mmHg: 0-12.5, 0-25, 0-50, 0-75, 0-100, 0-150 kPa: 0-1.7, 0-3.3, 0-6.6, 0-10.0, 0-13.3, 0-20.0
<b>Default:</b>	mmHg: 0-50 kPa: 0-6.6

### Default EtCO<sub>2</sub> Comp Setting

This parameter allows you to set the default compensation for CO<sub>2</sub>.

Values are as follows:

<b>Possible Values:</b>	None, O <sub>2</sub> , N <sub>2</sub> O, O <sub>2</sub> & N <sub>2</sub> O
<b>Default:</b>	None

## Power Save Mode at Power Up

When this parameter is set to Yes, the unit automatically enters EtCO<sub>2</sub> power save mode when powered on with a CAPNOSTAT sensor connected. The user must then enable the EtCO<sub>2</sub> device using the **Param/EtCO2** softkey menu before use.

Values are as follows:

<b>Possible Values:</b>	Yes, No
<b>Default:</b>	No

## EtCO<sub>2</sub> Average On Power Up

This parameter sets the default time period over which the EtCO<sub>2</sub> values are averaged.

Values are as follows:

<b>Possible Values:</b>	1 breath, 10 seconds, 20 seconds
<b>Default:</b>	10 seconds



## Printer & Report Settings

The Printer and Report Config settings are attributes that control what and how things are printed:

- Set Report Restart Delays
- Auto Generate Strips
- Print 3 Leads When Leads Sel.

**Note:** Printing is not available in AED mode.

### Set Report Restart Delays

This setting allows you to review or change the length of time the device must be turned off before it automatically erases all summary report and full disclosure data.

Values are as follows:

<b>Possible Values:</b>	5 Min, 15 Min, 30 Min, 90 Min, 6 Hours, 1.5 Days, 3 Days, Manual
<b>Default:</b>	6 Hours

### Auto Generate Strips

This setting allows you to set the strip chart recorder to automatically begin printing after a defibrillator discharge or whenever alarms are triggered while in Manual mode.

Values are as follows:

<b>Possible Values:</b>	Yes, No
<b>Default:</b>	Yes

### Print 3 Leads When Leads Sel.

This setting allows you to specify whether or not the strip chart recorder prints three (3) simultaneous leads of the patient ECG when Leads are selected and a 5- lead cable is in use.

Values are as follows:

<b>Possible Values:</b>	Yes, No
<b>Default:</b>	No

## Readiness Test Settings

The Readiness Test settings are attributes that control how and when the R Series unit is self-tested. It includes the following settings:

- Automatic Readiness Test
- Readiness Test Time
- Print Readiness Test Results
- Enable Readiness Test Audible Alert (Future Use)
- One Step Padz Installed

### Automatic Readiness Test

This setting allows you to specify whether the R Series unit performs the automatic device check.

Values are as follows:

<b>Possible Values:</b>	Off, Once a Day
<b>Default:</b>	Once a Day

### Readiness Test Time

This setting allows you to specify what time the R Series unit performs the automatic device check, if Automatic Device Check is set to Once a Day.

The Automatic Check Time is skipped if the unit is powered on, or has been powered off for less than 30 seconds. A record is not created and the Check/X indicator is not changed.

Values are as follows:

<b>Possible Values:</b>	12:00, 1:00, 2:00, 3:00, 4:00, 5:00, 6:00, 7:00, 8:00, 9:00, 10:00, 11:00 am or pm
<b>Default:</b>	12:00 am

### Print Readiness Test Results

This setting allows you to specify whether the R Series unit prints the results of the automatic device check at the completion of the check, if Automatic Device Check is set to Once a Day. If you want the unit to print results only when a failure is detected during the device check, set this setting to Only If Fail.

Values are as follows:

<b>Possible Values:</b>	Yes, No, Only if Fail
<b>Default:</b>	Only if Fail

## Enable Readiness Test Audible Alert (Future Use)

This setting allows you to specify whether the unit emits a beep when the automatic device check fails.

Values are as follows:

<b>Possible Values:</b>	No
<b>Default:</b>	No

## One Step Padz Installed

This setting allows you to specify whether the R Series unit tests the R Series OneStep electrodes as part of the readiness test check, and which electrodes it tests.

- If this setting is set to any of its values (including No or Base), and CPR, MwP or Complete electrodes are detected, they will be tested and the resulting status (pass/fail) is included in the readiness result.
- If this setting is set to CPR/MwP/Complete, and none of these OneStep electrodes are connected, or if the cable is not connected to the unit, the readiness result will indicate a failure (Electrode: Not Connected).
- If this setting is set to Base or No, and the cable is correctly connected to a short (Base electrode package, test port, or paddles in the wells), the unit will perform the readiness test and not fail based on electrode type.

**Note:** Use only cables that are intended for the R Series unit. If a cable for another ZOLL product is plugged in, the message *INVALID ADAPTER* may appear.

Values are as follows:

<b>Possible Values:</b>	CPR/MwP/Complete, No, Base
<b>Default:</b>	CPR/MwP/Complete

**Note:** The OneStep Padz Installed option should be set to Base unless you are using OneStep electrodes marked Rev. B or above:

8900-0212-XX Rev. B or above for OneStep Pacing  
 8900-0213-XX Rev. B or above for OneStep CPR  
 8900-0214-XX Rev. B or above for OneStep Complete

## AED Mode

The AED parameters are attributes that affect functions related to performing defibrillation with an R Series unit in AED mode and include:

- Display ECG in AED Mode
- Display HR in AED Mode
- Manual Confirm Enable
- Extra CPR Interval Before 1st Analysis
- Duration of Extra CPR Interval
- Display Remaining CPR Timer

### Display ECG in AED Mode

This parameter allows you to set the unit to either display or not display the patient's ECG trace on the monitor while in AED mode.

Values are as follows:

<b>Possible Values:</b>	Yes, No
<b>Default:</b>	Yes

### Display HR in AED Mode

This parameter allows you to set the unit to display the patient heart rate on the monitor while in AED mode.

Values are as follows:

<b>Possible Values:</b>	Yes, No
<b>Default:</b>	No

### Manual Confirm Enable

This parameter allows you to set a confirmation key to enter Manual mode.

Values are as follows:

<b>Possible Values:</b>	Yes, No
<b>Default:</b>	No

## Extra CPR Interval Before 1st Analysis

This parameter pertains only to AED mode.

When this parameter is set to No (default), and the unit detects a pad connection upon power-on, it automatically starts an ECG analysis. If the unit is powered on with no pads connected, the unit displays the *ATTACH PADS* prompt until pads are connected. Once pads are connected, the unit automatically starts an ECG analysis.

When this parameter is set to Yes, the unit displays the prompts: *CHECK PULSE* for 10 seconds, then *IF NO PULSE, PERFORM CPR* for the configured Extra CPR interval at power on. At the end of the CPR period, if the unit does not detect a pads connection, it displays the prompt *ATTACH PADS* until pads are connected. If a pads connection is detected, the unit automatically starts an ECG analysis. You can start an ECG analysis during the CPR interval by pressing the **ANALYZE** softkey.

Values are as follows:

<b>Possible Values:</b>	Yes, No
<b>Default:</b>	No

## Duration of Extra CPR Interval

This parameter allows you to specify the duration of the extra CPR interval (see previous entry). It has no effect if “Extra CPR Interval Before 1st Analysis” is set to No.

Values are as follows:

<b>Possible Values:</b>	0.5, 1, 1.5, 2, 2.5, 3, 3.5 or 4 minutes
<b>Default:</b>	2 minutes

## Display Remaining CPR Timer

This parameter allows you to specify whether to display remaining CPR interval during CPR.

Values are as follows:

<b>Possible Values:</b>	Yes, No
<b>Default:</b>	Yes

## Wi-Fi Settings (Optional)

The Wi-Fi settings are attributes that control how files are transferred and the security method used. Wi-Fi settings are stored in the Data COMM II Wi-Fi card and cannot be written to compact flash cards. Wi-Fi settings can be copied from one Wi-Fi card to another.

### Configuring a Wi-Fi Card

The default Wi-Fi settings are shown the first time the Wi-Fi Configuration screen is shown. The available settings may differ depending on whether a Wi-Fi card is installed and the type of card installed.

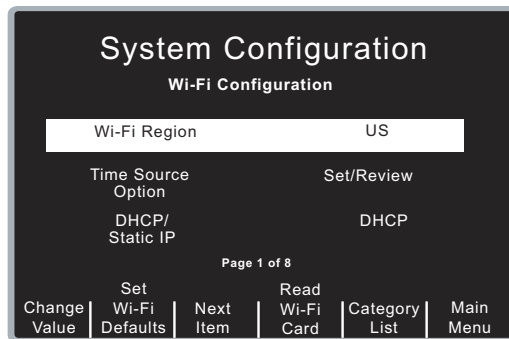

With the first option “Wi-Fi Region” selected, the R Series displays two softkeys which are not available otherwise:

Set Wi-Fi Defaults	Press this softkey to change the currently displayed Wi-Fi settings to the original default values. The settings in the installed Wi-Fi card are not affected.  Press the <b>Confirm</b> softkey to confirm resetting the default options or <b>Cancel</b> to return to the previous screen without changing the settings.
Read Wi-Fi Card	Press this softkey to read and review the configuration settings from the installed Wi-Fi card. The currently displayed options will be overwritten with the settings read from the Wi-Fi card.

Use the **Next Item** and **Change Value** softkeys to modify the settings.

To save the current Wi-Fi configuration settings to the inserted Wi-Fi card, press the **Next Item** softkey until the last item of the last screen page is selected (“Add Root Certificate” on page 8). The **Save to Wi-Fi Card** softkey becomes available; press this softkey to save the current Wi-Fi configuration settings to the inserted card.

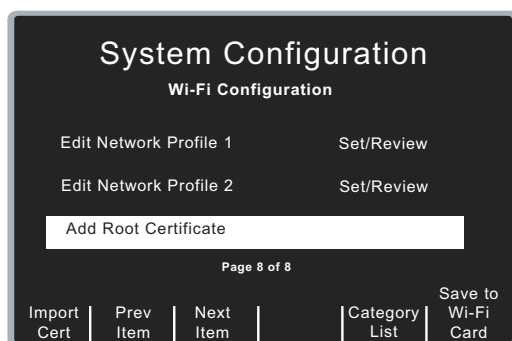

## Copying a Wi-Fi Configuration to Another Wi-Fi Card

You can copy a Wi-Fi configuration to another Wi-Fi card. You can also create a unique Wi-Fi configuration and copy it to multiple Wi-Fi cards at one time.

**Note:** It is not possible to transfer certificates from one Wi-Fi card to another. See the section “Copying Wi-Fi Configurations With Certificates” on page 67 for information on how to copy certificates to more than one Wi-Fi card.

Follow these steps to copy the Wi-Fi configuration from one card to another:

1. Install the Wi-Fi card whose configuration is to be copied.
2. If not already selected, use the **Prev Item** softkey to select the first Wi-Fi option “Wi-Fi Region” so the **Read Wi-Fi Card** softkey is visible on the screen.
3. Press **Read Wi-Fi Card**.
4. Use the **Next Item** softkey to review the settings and make changes if necessary. Continue until you reach the last option on the last page (“Add Root Certificate”) and the **Save to Wi-Fi Card** softkey is visible.
5. Remove the existing Wi-Fi Card and insert the new Wi-Fi card to which the current settings will be uploaded.
6. Press the **Save to Wi-Fi Card** softkey to save the changes to the newly installed card.

To copy the configuration to additional cards, remove the previously configured card and replace it with the next card to be configured. The **Save to Wi-Fi Card** softkey label will be removed and then will reappear when the new card has been detected. This process can be repeated with as many Wi-Fi cards as necessary.

## Entering Alphanumeric Information

Network names, passwords, IP addresses, and ports can be entered using the alphanumeric onscreen keypad. The ... key allows you to select upper case letters and other symbols. Use the arrow keys ← → to move through the character selection table; press **Enter Char** to select the highlighted character.

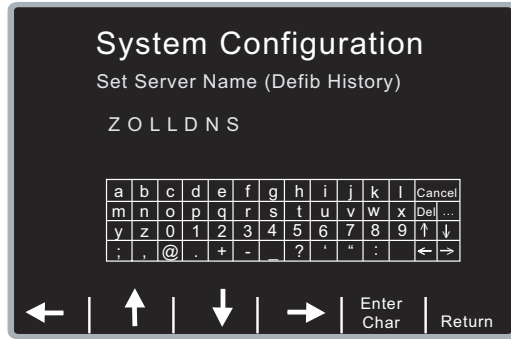

### Entering Passwords

For security reasons, “###” is displayed if the text field is a password or security key. When entering a new password, the “###” must be replaced with the new password before pressing the **Return** softkey. If **Return** is selected when “###” is displayed in the password field, the previously configured password is still used.

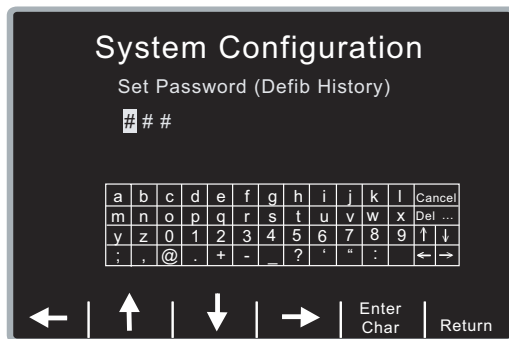

### Wi-Fi Menu Options

This section lists default values for the R Series Wi-Fi menu options. See “Wi-Fi Authentication Network Configuration Procedures” on page 69 for specific instructions on how to set up your Wi-Fi network configuration.

#### Wi-Fi Region

This setting displays a pre-selected Wi-Fi region (United States, Japan, or Europe). This factory selection cannot be changed unless the field displays “Not Set.” If the field displays “Not Set,” the setting must be changed to the appropriate region before the Wi-Fi card can be used.

Values are as follows:

<b>Possible Values:</b>	US, EU, JP, Not Set (upgraded units only)
<b>Default:</b>	US



## Time Source Option

This setting allows you to set the source of your synchronized clock settings.

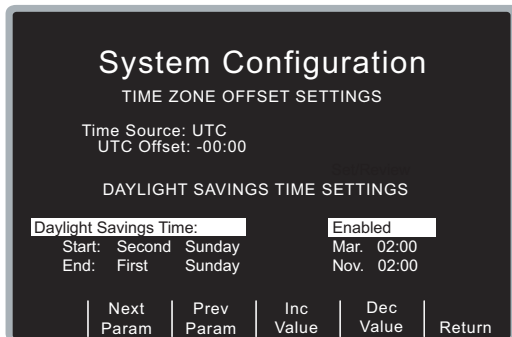

You can choose either UTC (Universal Time Coordinated) or a local data server as the source.

Values are as follows:

<b>Possible Values:</b>	Local, UTC
<b>Default:</b>	Local

Use the **Next Param** and **Prev Param** softkeys to move between the fields; use the **Inc Value** and **Dec Value** to change the parameters.

If set to Local, all other settings are greyed out. If set to UTC, you can select a UTC offset time in hours and minutes.

Values are as follows:

<b>Possible Values:</b>	+, - Hours: 00-12 Minutes: 00, 15, 30, 45
<b>Default:</b>	-00:00

If the Daylight Savings Time option is set to Enabled, you can then set the date and hour of both the beginning and end of Daylight Savings Time.

Values are as follows:

<b>Possible Values:</b>	Enabled, Disabled  <b>Start:</b> First, Second, Third, Fourth, Last Sunday, Monday, Tuesday, Wednesday, Thursday, Friday, Saturday Jan., Feb., Mar., Apr., May, June, July, Aug., Sep., Oct., Nov., Dec. Hours: 00-23 Minutes: 00, 15, 30, 45  <b>End:</b> First, Second, Third, Fourth, Last Sunday, Monday, Tuesday, Wednesday, Thursday, Friday, Saturday Jan., Feb., Mar., Apr., May, June, July, Aug., Sep., Oct., Nov., Dec. Hours: 00-23 Minutes: 00, 15, 30, 45
<b>Default:</b>	Disabled Start: Second Sunday Mar. 02:00 End: First Sunday Nov. 02:00

**Note:** Time Sync must be set to Yes in the Data Transfer menu.

### DHCP/Static IP

This setting allows you to either manually set the static IP address or retrieve the IP address from a DHCP server. If this setting is set to Static IP, you need to set the following settings: Gateway IP Address, Subnet Mask, and local IP Address.

Values are as follows:

<b>Possible Values:</b>	Static IP, DHCP
<b>Default:</b>	DHCP

### Local IP Address

This setting allows you to specify the defibrillator's IP address used in the static configuration. This setting is available only when DHCP/Static IP is set to Static IP.

Values are as follows:

<b>Possible Values:</b>	XXX.XXX.XXX.XXX where XXX is 000 to 255
<b>Default:</b>	192.168.100.100

### Gateway IP Address

This setting allows you to specify the router's IP address used in the static configuration. This setting is accessible only when DHCP/Static IP is set to Static IP.

Values are as follows:

<b>Possible Values:</b>	XXX.XXX.XXX.XXX where XXX is 000 to 255
<b>Default:</b>	192.168.100.001

### Subnet Mask

This setting allows you to specify the subnet mask used in the static configuration. This setting is accessible only when DHCP/Static IP is set to Static IP.

Values are as follows:

<b>Possible Values:</b>	XXX.XXX.XXX.XXX where XXX is 000 to 255
<b>Default:</b>	255.255.255.000

### Primary/Secondary DNS IP Address

This setting allows you to specify the Primary and Secondary IP address of the DNS server to use when Use Host Name setting is set to Yes, and DHCP/Static IP setting is set to Static IP.

Values are as follows:

<b>Possible Values:</b>	XXX.XXX.XXX.XXX where XXX is 000 to 255
<b>Default:</b>	192.168.100.2

### Use Host Name

This setting allows you to specify whether to use a DNS to obtain the server IP address from the server name.

Values are as follows:

<b>Possible Values:</b>	Yes, No
<b>Default:</b>	Yes

### Server Hostname (Full Disclosure)

This setting allows you to specify the server name string to use (up to 255 characters) if the Use Host Name setting is set to Yes.

**Allowable characters:**

A-Z, a-z, 0-9

-. (hyphen, period)

### Server IP (Full Disclosure)

This setting allows you to specify the server IP address to use if Use Host Name is set to No.

Values are as follows:

<b>Possible Values:</b>	XXX.XXX.XXX.XXX where XXX is 0 to 255
<b>Default:</b>	000.000.000.000

**Server Port (Full Disclosure)**

This setting allows you to specify the TCP port used to connect with the server.

Values are as follows:

<b>Default:</b>	443
-----------------	-----

**Username (Full Disclosure)**

This setting specifies the username assigned to connect to the ZOLL Data Exchange Service (DXS) running on the Full Disclosure server. It is up to 63 characters in length.

**Password (Full Disclosure)**

This setting specifies the password assigned to connect to the ZOLL Data Exchange Service (DXS) running on the Full Disclosure server. It is up to 63 characters in length.

**Server Hostname (Defib History)**

This setting allows you to specify the server name string to use (up to 255 characters) if Use Host Name is set to Yes.

Allowable characters:

A-Z, a-z, 0-9

-. (hyphen, period)

**Server IP (Defib History)**

This setting allows you to specify the server IP address to use if Use Host Name is set to No.

Values are as follows:

<b>Possible Values:</b>	XXX.XXX.XXX.XXX where XXX is 0 to 255
<b>Default:</b>	000.000.000.000

**Server Port (Defib History)**

This setting allows you to specify the TCP port used to connect with the server.

Values are as follows:

<b>Default:</b>	443
-----------------	-----

**Username (Defib History)**

This setting specifies the username assigned to connect to the ZOLL Data Exchange Service (DXS) running on the Defib History server. It is up to 63 characters in length.

**Password (Defib History)**

This setting specifies the password assigned to connect to the ZOLL Data Exchange Service (DXS) running on the Defib History server. It is up to 63 characters in length.

## Network Profile Submenu Options

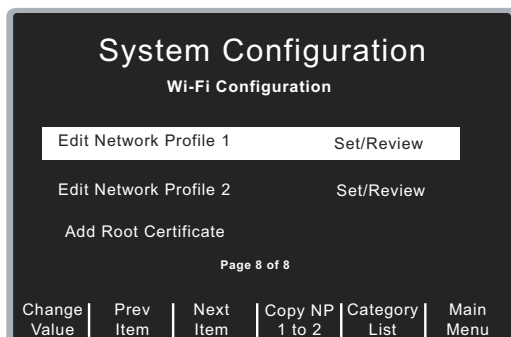

This section lists default values for the R Series Wi-Fi Network Profile submenu options. See “Wi-Fi Authentication Network Configuration Procedures” on page 69 for specific instructions on how to set up your Wi-Fi network configuration.

These settings constitute a Network Profile, identified by an SSID name. Two network profiles are supported. To use a profile, specify the SSID name as well as the remaining required settings.

If both profiles are configured, the Wi-Fi card will attempt to connect to the SSID specified in Network Profile 1. If that connection fails, the card will then attempt to connect to the SSID specified by Network Profile 2.

To use only one profile, leave the SSID name of the second profile blank.

To access Network Profile settings, use the **Prev Item** and **Next Item** softkeys to select Edit Network Profile 1 or Edit Network Profile 2. Press the **Change Value** softkey.

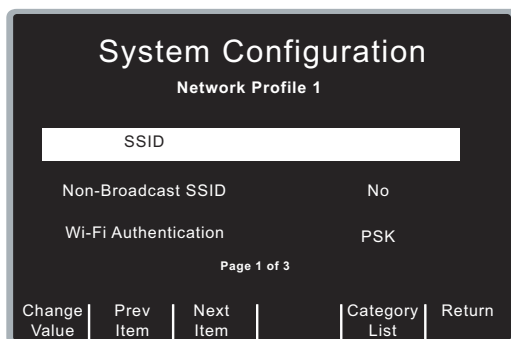

To exit the Network Profile and return to the previous screen, press the **Return** softkey.

If the two profiles have similar settings, you can reduce the data entry effort by entering information for a profile, and copying its contents to the other profile. To copy Network Profile 1 to Network Profile 2, use the **Prev Item** or **Next Item** softkey to select Edit Network Profile 1 and press the **Copy NP 1 to 2** softkey.

To copy Network Profile 2 to Network Profile 1, use the **Prev Item** or **Next Item** softkey to select Edit Network Profile 2 and press the **Copy NP 2 to 1** softkey.

## SSID

This setting allows you to specify the specific SSID string, with a 32 character limit.

**Allowable characters:**

A-Z, a-z, 0-9  
,@.-\_':%&(){}/\*=^~<>  
space

## Non-Broadcast SSID

This setting allows you to specify whether the SSID identifies a “hidden” network whose access point does not broadcast its SSID. Set this option to Yes only if the SSID is “hidden” or non-broadcast.

Values are as follows:

<b>Possible Values:</b>	Yes, No
<b>Default:</b>	No

## Wi-Fi Authentication

This setting allows you to specify the type of authentication used by the network. If set to PSK, the authentication method is pre-shared key, such as WPA or WPA2. If set to Enterprise, the authentication protocol is specified by the Authentication Protocol option.

Values are as follows:

<b>Possible Values:</b>	PSK, Enterprise
<b>Default:</b>	PSK

## Authentication Protocol

This setting allows you to specify the Enterprise authentication protocol when Wi-Fi Authentication is set to Enterprise. Set it to PEAP to use PEAP/MS CHAP v2 Enterprise authentication, or to TLS to use EAP-TLS.

Values are as follows:

<b>Possible Values:</b>	PEAP, TLS
<b>Default:</b>	PEAP

## User Identity

When using an Enterprise authentication protocol, this required setting is the user name assigned by your network administrator to connect to the network. It has a 63-character limit.

## User Password

When PEAP is selected, this required setting is the password assigned by your network administrator to connect to the network. It has a 63-character limit.

## Private Key Password

When TLS is selected, this required setting defines the password required to access the private key contained within the client certificate. It has a 63-character limit.

## Security Key

When PSK is selected, this setting allows you to specify the Wi-Fi security key. It has a 63-character limit.

## Certificate Setup

If using Enterprise networking, you must install the complete certificate chain for the Active Directory or RADIUS server used by the network to authenticate clients to the network. The Enterprise authentication protocols require the use of root certificates issued by a certificate authority (CA). The Wi-fi card supports X.509 certificates. Certificate chains are also supported. You can install the certificates in either “.pem”, “.der” or “.p7b” form.

If TLS is selected, a client certificate is also required. This setting is the name of the client certificate file. Client certificate files must be encoded in the PFX (Personal Information Exchange) format. The file must include the certificate as well as the private key. The filename must have a .pfx extension. Certificate filenames cannot exceed a maximum length of 23 characters, including the extension.

To use certificate files with the R Series unit, copy the certificate files to a compact flash card which has been formatted using the PC FAT file system. The files must be stored in the card’s root directory. The R Series unit imports the selected certificates from the compact flash card and uploads them to the Wi-Fi card.

The R Series can display up to 9 certificate filenames of each type in its file selection list.

## Adding a Root Certificate

The Data COMM II Wi-Fi card includes a root certificate issued by ZOLL for its Data Exchange Service (DXS) server. Adding a root certificate is only needed for a PSK network using a non-ZOLL DXS root certificate or for Enterprise networking.

You can upload only one root certificate at a time

Step	Action
1.	In Wi-Fi Configuration, press the Next Item softkey until Add Root Certificate is selected. <div data-bbox="1019 1339 1412 1596" style="float: right; border: 1px solid black; padding: 5px; margin-top: 10px;"> </div>
2.	Remove the Wi-Fi card from the R Series unit, if currently installed.
3.	Insert the compact flash card containing the certificates.

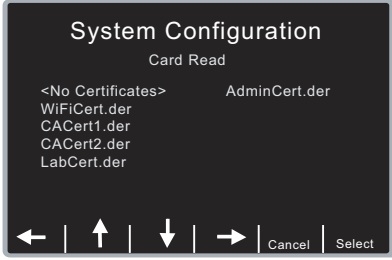
Step	Action
4.	<p>Press the <b>Import Cert</b> softkey. The R Series unit reads the compact flash card and displays a list of .der, .pem, and .p7b files available for selection. The “No Certificates” selection is always displayed and allows you to clear the Certificate field.</p>
	
5.	<p>Use the arrow softkeys to select the certificate to be added and press the <b>Select</b> softkey to make the selection and read the certificate, or <b>Cancel</b> to return to the previous screen without changing the selection.</p>
6.	<p>Remove the compact flash card containing the certificates and insert the Wi-Fi card.</p>
7.	<p>To upload the certificate to the Wi-Fi card, press the <b>Save to Wi-Fi Card</b> softkey. This will also upload the current Wi-Fi configuration settings to the card.</p>

You can upload only one root certificate at a time. A single root certificate is uploaded to the Wi-Fi card each time the Save to Wi-Fi Card softkey is pressed.

### Configuring a Client Certificate

You can configure one client certificate per network profile. The process is similar to that of importing a root certificate.

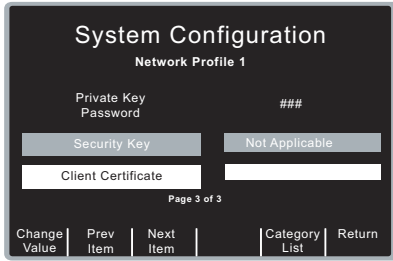
Step	Action
1.	<p>In Wi-Fi Configuration, select the Network Profile to associate with the client certificate. Press the <b>Change Value</b> softkey to access the Network Profile settings.</p>
2.	<p>Press the <b>Next Item</b> softkey until “Client Certificate” is selected. If the Wi-Fi card’s profile already contains a client certificate, the filename will be displayed.</p>
	

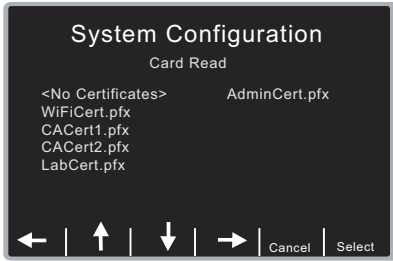

Step	Action
3.	Remove the Wi-Fi card from the R Series unit, if currently installed.
4.	Insert the compact flash card containing the certificates.
5.	<p>Press the <b>Import Cert</b> softkey. The R Series unit reads the compact flash card and displays a list of .pfx files available for selection. The “No Certificates” selection is always displayed and allows you to clear the Certificate field.</p> 
6.	Use the arrow softkeys to select the certificate to be added and press the <b>Select</b> softkey to make the selection and read the certificate, or <b>Cancel</b> to return to the previous screen without changing the selection. The name of the certificate to be written to the Wi-Fi card is shown.
7.	Remove the compact flash card containing the certificates and insert the Wi-Fi card.
8.	<p>To upload the certificate to the Wi-Fi card, press the <b>Save to Wi-Fi Card</b> softkey. This will also upload the current Wi-Fi configuration settings to the card.</p> <p>The client certificate written to the card will replace an existing certificate of the same name, if it exists.</p>

To delete the client certificate in use without specifying a replacement, select the “No Certificates” entry and then press the **Save to Wi-Fi Card** softkey. The certificate will not be deleted until the changes are written to the Wi-Fi card.

### Copying Wi-Fi Configurations With Certificates

Certificate files can only be uploaded to the installed Wi-Fi card if they have been read into memory from a compact flash card. Reading the Wi-Fi configuration from a Wi-Fi card retrieves client certificate filenames, but not their contents. Root certificate filenames are not read.

To copy a configuration with certificates to several Wi-Fi cards, you need to read the required certificates into the R Series unit first. A maximum of three certificates can be read and copied at one time: one root certificate, the client certificate for Network Profile 1, and the client certificate for Network Profile 2. Root certificates are added to the card’s internal list, while client certificates replace the current client certificates on the card.

The following steps give an overview of the process:

1. Insert the compact flash card containing the certificates.
2. Import the required certificates as described above.

3. Remove the compact flash card.
4. Adjust any other required configuration settings which will be common to all Wi-Fi cards. Do not read the contents of the Wi-Fi card, as this will erase the certificate from R Series memory.
5. Install a Wi-Fi card and press the **Save to Wi-Fi Card** softkey to write the settings to the card.

Steps 4 and 5 can be repeated with as many cards as necessary. The contents of the certificate files will remain in R Series memory until any of the following events occurs:

- Another certificate file is read
- The contents of a Wi-Fi card are read using the **Read Wi-Fi Card** softkey
- The Wi-Fi settings are set to the defaults using the **Set Wi-Fi Defaults** softkey
- The R Series unit exits System Configuration mode

---

**Warning!** If a client certificate name has been specified in a cloned configuration but the corresponding certificate has not been uploaded to the cloned card, then the configuration is invalid.

---

## Wi-Fi Authentication Network Configuration Procedures

This section describes the procedures for setting up four possible network configurations:

- Network with Static Addresses
- Network with DHCP
- Network with DHCP and DNS
- Enterprise Network

Each network scenario consists of:

- the R Series unit and the inserted Data COMM II Wi-Fi card. Verify that the card is seated properly with the R Series name facing in the slot.
- an Access Point (AP)
- the User Network
- the ZOLL Data Exchange Service (DXS) server for receiving Full Disclosure and Defib History files

### Network with Static Addresses

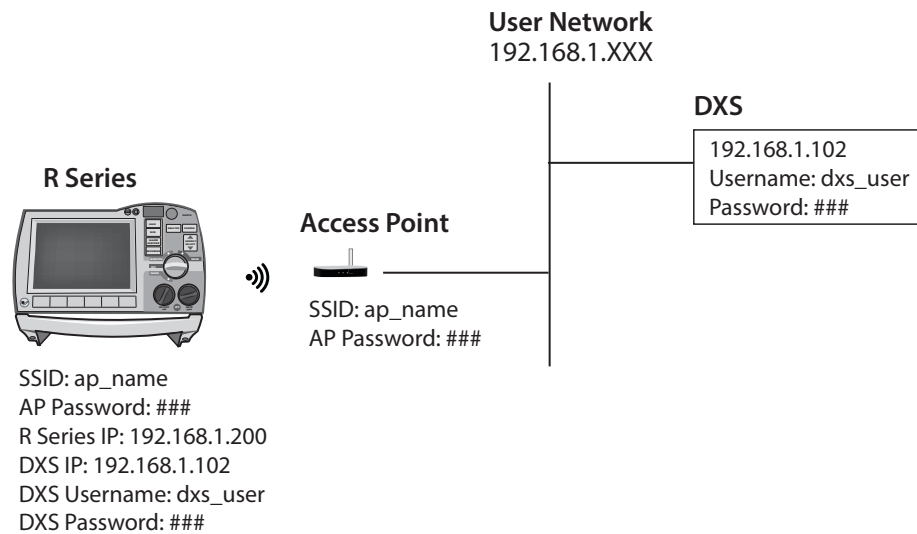

Step	Action
1.	<p>From the Select Configuration Categories screen, select Wi-Fi, then press the <b>Enter</b> softkey. The Wi-Fi Configuration screen appears.</p> <p>On page 1, press the <b>Next Item</b> softkey to highlight <b>DHCP/Static IP</b> and press the <b>Change Value</b> softkey to select <b>Static IP</b>.</p>

**System Configuration**  
Wi-Fi Configuration

Wi-Fi Region: US

Time Source Option: Set/Review

DHCP/Static IP: DHCP

Page 1 of 8

Set Read

Change Value | Wi-Fi Defaults | Next Item | Wi-Fi Card | Category List | Main Menu

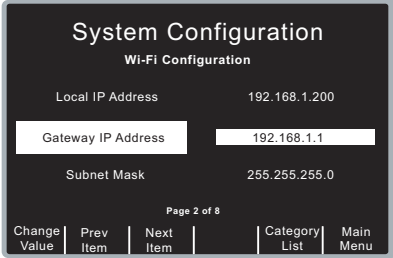
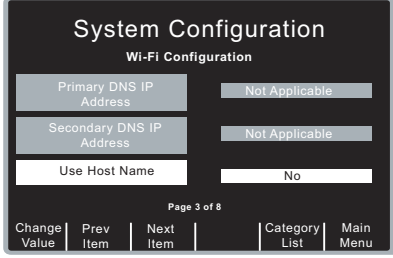
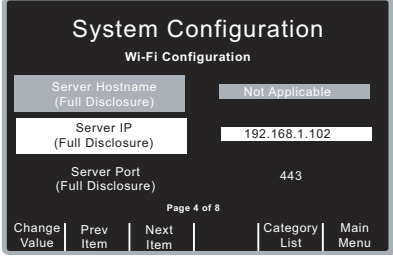
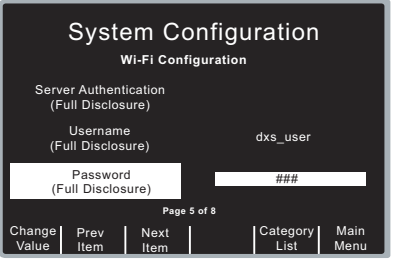
Step	Action
2.	<p>On page 2, enter the R Series IP address information.</p> 
3.	<p>On page 3, for <b>Use Host Name</b>, select <b>No</b>.</p> 
4.	<p>On page 4, enter the IP address of the DXS for the Full Disclosure server. When a DXS is specified by IP address, the R Series automatically authenticates the DXS using its built-in certificate.</p> 
5.	<p>On page 5, enter the Username and Password of the DXS for the Full Disclosure server.</p> 
6.	<p>On pages 6 and 7, use this same procedure to enter the IP address and DXS information for the Defib History server.</p>

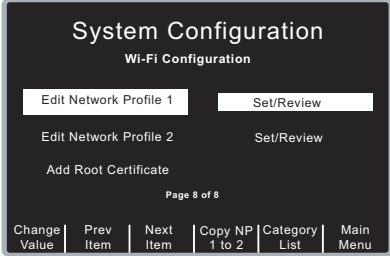
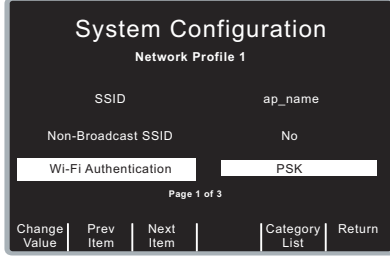
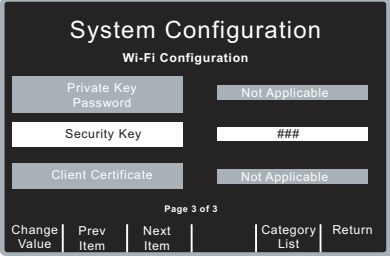
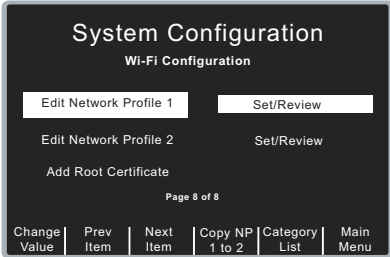
Step	Action
7.	<p>On page 8, select <b>Edit Network Profile 1</b>; press <b>Change Value</b>.</p> 
8.	<p>On page 1 of the Network Profile submenu, enter the <b>SSID</b> name and set <b>Wi-Fi Authentication</b> to <b>PSK</b>.</p> 
9.	<p>Press <b>Next Item</b> to advance to page 3 (page 2 is skipped). Enter the security key of the Access Point.</p> 
10.	<p>When finished, press <b>Return</b>. The unit returns to page 8 of the Wi-Fi Configuration screen.</p> 
11.	<p>Press <b>Next Item</b> to scroll to the final item on the screen (<b>Add Root Certificate</b>). This changes the softkey field options. Press <b>Save to Wi-Fi Card</b>.</p>

## Network with DHCP

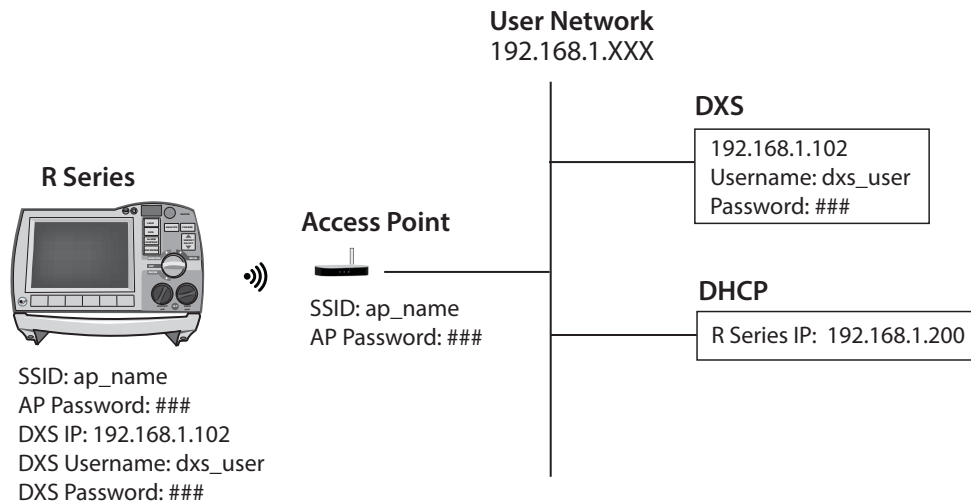

Step	Action	
1.	<p>From the Select Configuration Categories screen, select Wi-Fi, then press the <b>Enter</b> softkey. The Wi-Fi Configuration screen appears.</p> <p>On page 1, press the <b>Next Item</b> softkey to highlight <b>DHCP/Static IP</b> and press the <b>Change Value</b> softkey to select <b>DHCP</b>.</p>	
2.	<p>Press <b>Next Item</b> to advance to page 3 (page 2 is skipped). For <b>Use Host Name</b>, select <b>No</b>.</p>	
3.	<p>On page 4, enter the IP address of the DXS for the Full Disclosure server. When a DXS is specified by IP address, the R Series automatically authenticates the DXS using its built-in certificate.</p>	

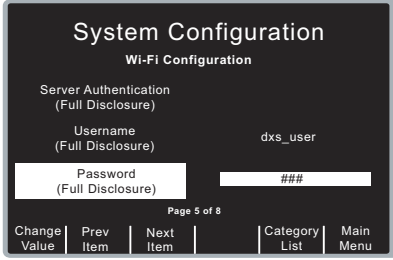
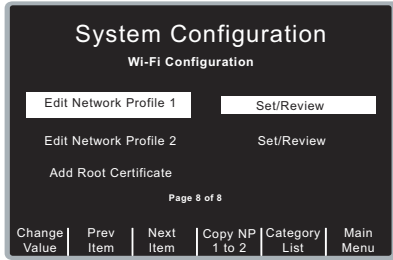
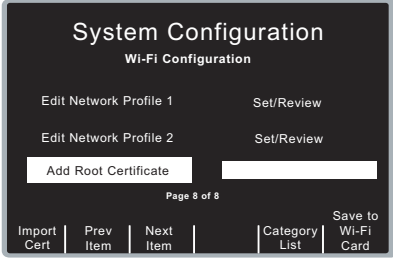
Step	Action
4.	<p>On page 5, enter the Username and Password of the DXS for the Full Disclosure server.</p> 
5.	<p>On pages 6 and 7, use this same procedure to enter the IP address and DXS information for the Defib History server.</p>
6.	<p>On page 8, select Edit Network Profile 1 and enter the same information as for the “Network with Static Addresses” example above on page 71.</p> 
7.	<p>When finished, press <b>Return</b>. Press <b>Next Item</b> to scroll to the final item on the screen (<b>Add Root Certificate</b>). This changes the softkey field options. Press <b>Save to Wi-Fi Card</b>.</p> 

## Network with DHCP and DNS

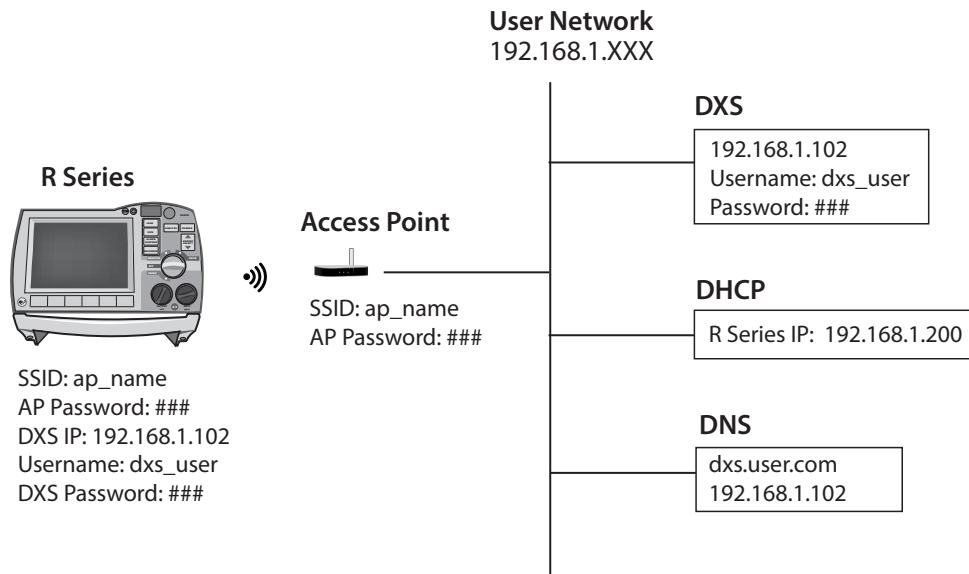

Step	Action	
1.	<p>From the Select Configuration Categories screen, select Wi-Fi, then press the <b>Enter</b> softkey. The Wi-Fi Configuration screen appears.</p> <p>On page 1, press the <b>Next Item</b> softkey to highlight <b>DHCP/Static IP</b> and press the <b>Change Value</b> softkey to select <b>DHCP</b>.</p>	
2.	<p>Press the <b>Next Item</b> softkey to advance to page 3 (page 2 is skipped). Set <b>Use Host Name</b> to <b>Yes</b>.</p>	

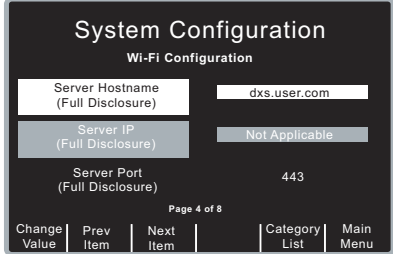
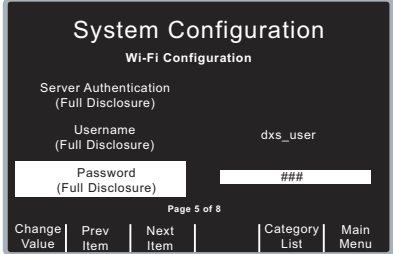
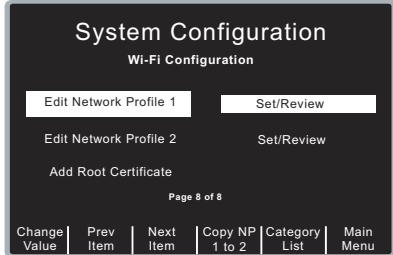
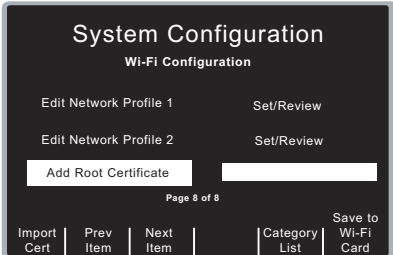

Step	Action
3.	<p>On page 4, enter the Server Hostname.</p> <p><b>Note:</b> When hostnames are used, the user must load a root certificate from the server hosting the DXS.</p> 
4.	<p>On page 5, enter the Username and Password of the DXS for the Full Disclosure server.</p> 
5.	<p>On pages 6 and 7, use this same procedure to enter the IP address and DXS information for the Defib History server.</p>
6.	<p>On page 8, select Edit Network Profile 1 and enter the same information as for the “Network with Static Addresses” example above on page 71.</p> 
7.	<p>Press <b>Next Item</b> to scroll to <b>Add Root Certificate</b>.</p> 
8.	<p>Remove the Wi-Fi card and replace it with the compact flash card containing the client certificate (see “Adding a Root Certificate” on page 65 above for specific instructions).</p>

Step	Action
9.	The unit returns to page 8 of the Wi-Fi Configuration screen. Replace the compact flash card with the Wi-Fi card. Press <b>Next Item</b> to scroll to the final item on the screen ( <b>Add Root Certificate</b> ). This changes the softkey field options. Press <b>Save to Wi-Fi Card</b> .

## Enterprise Network

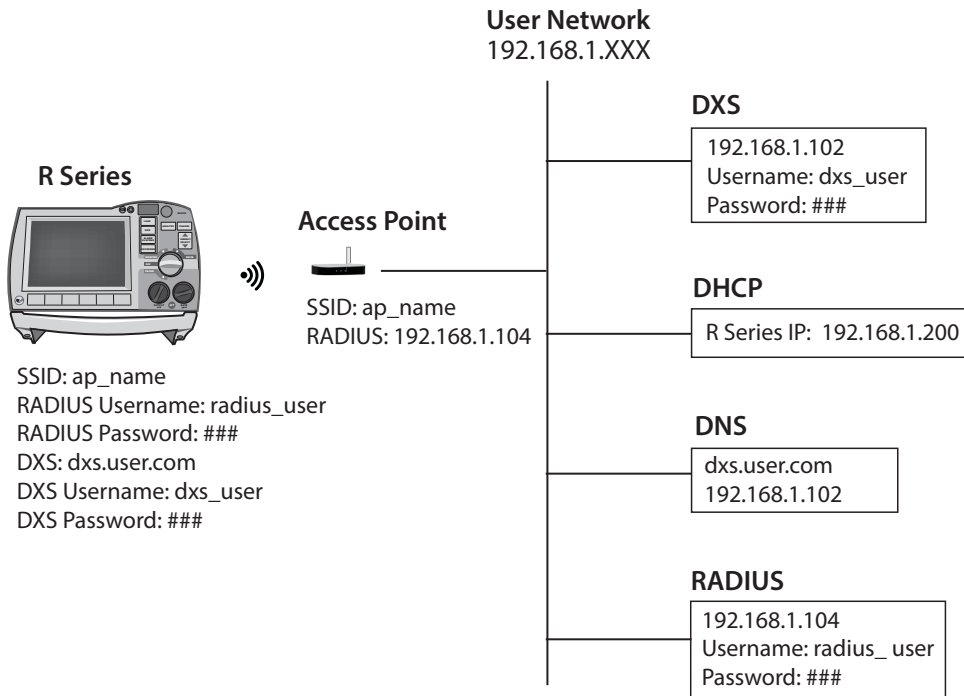

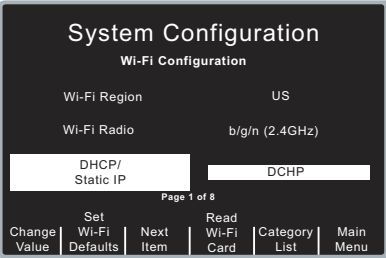
Step	Action
1.	<p>From the Select Configuration Categories screen, select Wi-Fi, then press the <b>Enter</b> softkey. The Wi-Fi Configuration screen appears.</p> <p>Select the desired values on pages 1-7, as shown in the previous network configurations.</p> 
2.	On page 8, select <b>Edit Network Profile 1</b> .

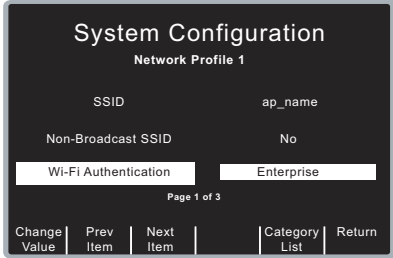
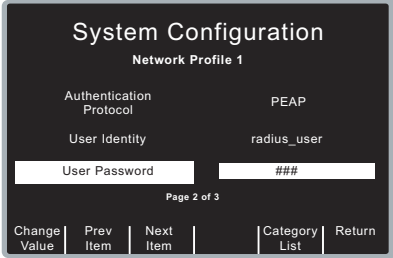
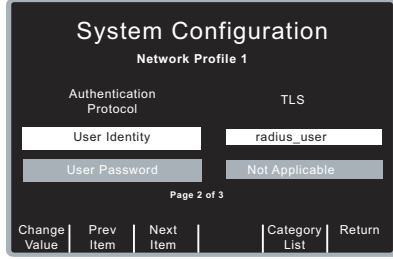
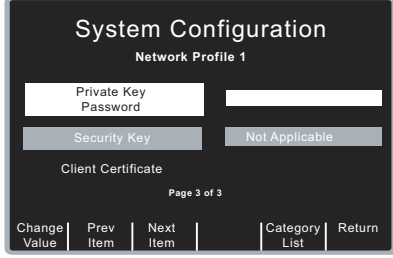
Step	Action
3.	<p>On page 1 of the Network Profile submenu, enter the SSID name and set <b>Wi-Fi Authentication</b> to <b>Enterprise</b>.</p> 
4.	<p>On page 2, for <b>Authentication Protocol</b>, select either <b>PEAP</b> or <b>TLS</b>.</p>
5.	<p>PEAP:            Set the <b>User Identity</b> to <b>radius_user</b>.            Set the <b>User Password</b>.            There are no additional PEAP options on page 3 of the Network Profile submenu.            Press <b>Return</b> to accept all changes and return to page 8 of the Wi-Fi Configuration screen. Press <b>Next Item</b> to scroll to the final item on the screen (<b>Add Root Certificate</b>). This changes the softkey field options. Press <b>Save to Wi-Fi Card</b>.</p> 
6.	<p>TLS:            Set the User Identity to radius_user. The User Password field is greyed out.            Remove the Wi-Fi card and replace it with the CF card containing the client certificate.            Press the Next Item softkey to advance to page 3 of the Network Profile submenu.</p> 
7.	<p>On page 3, set the <b>Private Key Password</b>.</p> 

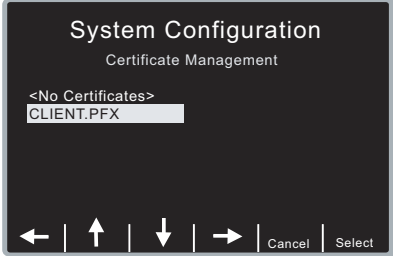
Step	Action
8.	<p>Press the Next Item softkey to select Client Certificate.</p> <p>Press <b>Import Cert</b>, and use the arrow keys to select the certificate file. Press <b>Select</b>.</p> 
9.	<p>The unit returns to page 3 of the Network Profile submenu. Press <b>Return</b> to accept all changes and return to page 8 of the Wi-Fi Configuration screen.</p>
10.	<p>On page 8, press <b>Next Item</b> scroll to <b>Add Root Certificate</b>. Remove the Wi-Fi card and replace it with the compact flash card containing the client certificate (see “Adding a Root Certificate” on page 65 above for specific instructions).</p>
11.	<p>The unit returns to page 8 of the Wi-Fi Configuration screen. Replace the compact flash card with the Wi-Fi card. Press <b>Next Item</b> to scroll to the final item on the screen (<b>Add Root Certificate</b>). This changes the softkey field options. Press <b>Save to Wi-Fi Card</b>.</p>

## Network Profile Configuration Summary

The user must set the following entries in the Network Profiles.

WPA/WPA2 PSK:

SSID	Required
Wi-Fi Authentication	PSK
Security key	Required

Enterprise with EAP-PEAP:

SSID	Required
Wi-Fi Authentication	Enterprise
Authentication Protocol	PEAP
User Identity	Required
User Password	Required
Root Certificate	Required

Enterprise with EAP-TLS:

SSID	Required
Wi-Fi Authentication	Enterprise
Authentication Protocol	TLS
User Identity	Required
Private Key Password	Required
Client Certificate	Required
Root Certificate	Required

### Notes:

1. The client certificate is in binary form and includes the user's private key.
2. The client certificate has an extension of .pfx.
3. If you are using the ZOLL root certificate, when configuring the R Series unit, you only have to fill in the host IP address. The Wi-Fi card will assign the host name.
4. The certificate of the domain controller (ACS server) is entered via the Add Root Certificate facility.

## Data Transfer Settings (Optional)

The Data Transfer settings are attributes that control which files are transferred, and whether to update the R Series unit's clock with the time from the network server following a transmission. It includes the following settings:

Full Disclosure Transfer Mode  
 Defib History Transfer Mode  
 Enable Report ID  
 Time Sync  
 Report Transfer Reminder  
 Enable Auto Case Upload  
 Delete After Auto Case Upload  
 Send .DCK File With .FUL File

### Full Disclosure Transfer Mode

This setting allows you to determine the following:

- whether full disclosure file transfers are supported
- whether the Send Report softkey is displayed

Values are as follows:

<b>Possible Values:</b>	Server, None
<b>Default:</b>	Server

### Defib History Transfer Mode

This setting allows you to specify whether device check files and activity log files will be transmitted, and determines whether Defib History to Wi-Fi softkey is displayed.

Values are as follows:

<b>Possible Values:</b>	Both, None, Manual, Automatic
<b>Default:</b>	None

### Enable Report ID

This setting allows you to enable or disable the option to enter a unique alphanumeric patient ID before Wi-Fi transmission of a Full Disclosure report. If set to No, the report will be sent automatically.

**Note:** Note: During an automatic Readiness Test, the Report ID is not included in the Full Disclosure report.

Values are as follows:

<b>Possible Values:</b>	Yes, No
<b>Default:</b>	No

## Time Sync

This setting allows you to specify whether the R Series will update its clock following a successful Defib History transmission.

The Defib History Transfer Mode must be set to Automatic or Both. The R Series unit uses the date and time of the Defib History Server to adjust its clock.

Values are as follows:

<b>Possible Values:</b>	Yes, No
<b>Default:</b>	Yes

## Report Transfer Reminder

This setting enables the display of a message to remind the user to transfer report data. If set to Yes, the message *TURN UNIT ON AND ENTER DATA TRANSFER MODE TO TRANSFER REPORT* is displayed for 15 seconds when the unit is turned off from a clinical mode.

Values are as follows:

<b>Possible Values:</b>	Yes, No
<b>Default:</b>	No

## Enable Auto Case Upload

This setting allows you to control automatic uploads of the Full Disclosure report. If set to Yes, the R Series unit transfers the report via Wi-Fi when the R Series dial is turned to the Off position, or during a Readiness Test. If set to No, the Full Disclosure report is not sent automatically.

For automatic uploads during a Readiness Test, the Automatic Readiness Test parameter must also be enabled; the Full Disclosure Transfer Mode settings are ignored.

When this feature is set to Yes, Report Restart Delay time is disabled (see page 51). If the case data is not successfully uploaded on the first attempt, it remains on the R Series unit until the next automatic upload is initiated.

Values are as follows:

<b>Possible Values:</b>	Yes, No
<b>Default:</b>	No

## Delete After Auto Case Upload

This setting allows you to control automatic deletions of a Full Disclosure file after it has been sent automatically. The Enable Auto Case Upload parameter must be enabled.

Values are as follows:

<b>Possible Values:</b>	Yes, No
<b>Default:</b>	No

## Send .DCK File With .FUL File

This setting allows you to send the .DCK (Device Check file) along with the .FUL (Full Disclosure file) for troubleshooting purposes. Values are as follows:

<b>Possible Values:</b>	Yes, No
<b>Default:</b>	No