

ZOLL®

AutoPulse® NXT



User Guide

©2024 ZOLL Medical Corporation. All rights reserved. ZOLL and AutoPulse are trademarks or registered trademarks of ZOLL Medical Corporation and/or its subsidiaries in the United States and/or other countries. All other trademarks are the property of their respective owners.



ZOLL Circulation, Inc.
2000 Ringwood Avenue
San Jose, CA 95131 USA
T: +1.408.541.2140
F: +1.408.541.1030



ZOLL International Holding B.V.
Einsteinweg 8A
6662 PW ELST
The Netherlands



ZOLL Medical Switzerland A.G.
Baarerstrasse 8
6300, Zug Switzerland



Patent: www.zoll.com/patents



IP44



Rxonly



Table of Contents

1. Introduction	1
AutoPulse® NXT System description	1
Intended purpose	1
Indications for use	1
Intended users	2
Intended patients	2
System components	2
AutoPulse NXT Platform	3
AutoPulse NXT Battery	3
AutoPulse NXT Battery Charger	3
AutoPulse NXT Band	3
Accessories	3
Clinical Benefits	3
Adjunctive therapies	3
2. Safety Information	5
Warnings and cautions	5
Symbols	6
3. Platform	9
Platform description	9
User control panel	10
Compression mode	12
Changing the compression mode	12
Mute settings	13
4. Band	15
Band description	15
Installing the band	16
Removing the band	19
5. Battery	21
Battery description	21
Handling new batteries	22
Battery status	22
Installing and removing the battery	23
Expected battery life	23
6. Battery Charger	25
Battery charger description	25
Setting up the battery charger	27
Using the battery charger	27
Charging the battery	27
Removing the battery	28
Battery charger panel	29

Table of Contents

Battery charger measurement cycle	30
Battery charger circuit breaker	31
7. Using the System	33
Required materials	33
Setting up the system	33
Deploying the system	33
Operating the system	34
Patient alignment and securing for transport	37
Patient extrication	37
Periodic Electrocardiogram (ECG) Monitoring and/or Defibrillation	38
Ending treatment	38
Preparing for next use	38
AutoPulse NXT Performance Report	39
Downloading the AutoPulse NXT performance report	40
8. Accessories	41
Quick Case™ Carry Sheet	41
Patient Safety	42
Attaching the platform to the Quick Case carry sheet	44
Folding the Quick Case carry sheet	46
Hygiene Barrier	49
Shoulder Restraint	50
Warnings	51
9. Maintenance and Transport	53
System inspection	53
Inspecting the platform	53
Inspecting the battery	53
Inspecting the battery charger	53
System cleaning	53
Cleaning system surfaces	54
Cleaning the platform	54
Cleaning the battery	54
Cleaning the battery charger	54
Cleaning the Quick Case carry sheet	54
Cleaning the shoulder restraint	54
Transport, shipping and storage	55
Transport	55
Shipping	55
Storage	55
Disposal	55
10. Warranty & Technical Support	57
ZOLL Factory Limited Warranty for AutoPulse NXT System	57
Technical Support	58
Appendix A. System Checklist	59

Appendix B. Troubleshooting	61
Troubleshooting the platform	61
Solid alert indicator	61
Flashing alert indicator	61
Troubleshooting the band	61
Cut bands	61
Retracting bands	62
Unable to reach the spool retention slots in the guard ports	62
Band not completely unwound from platform	62
Troubleshooting the battery	63
Troubleshooting the battery charger	64
Appendix C. Technical Specifications	65
System Operating Parameters	65
Platform Physical Specifications.....	65
Platform Environmental Specifications	65
Battery Physical and Environmental Specifications	66
Battery Charger Physical And Environmental.....	67
Guidance and Manufacturer’s Declaration–Electromagnetic Emissions	68
Electromagnetic Immunity Declaration (EID).....	69
Wireless Output Guidance and Manufacturer's Declaration	74
RF Transmission Emitted (IEC 60601-1-2).....	74
FCC Notice	74
Canada, Industry Canada (IC) Notices.....	74
Appendix D. Performance Report Alerts Table	75
Quick Reference Guide	77

This page intentionally left blank.

1. Introduction

This user guide describes the AutoPulse® NXT Resuscitation System (system), operating steps, warnings, cautions, and maintenance.

Proper use of the system requires a thorough understanding of the product, appropriate training, and practice. Read this user guide before operating the system, and retain it for future reference.

This chapter provides information on:

- "AutoPulse® NXT System description" (page 1)
- "Intended purpose" (page 1)
- "Indications for use" (page 1)
- "Intended users" (page 2)
- "Intended patients" (page 2)
- "System components" (page 2)
- "Clinical Benefits" (page 3)
- "Adjunctive therapies" (page 3)

AutoPulse® NXT System description

The AutoPulse NXT Resuscitation System is a portable system that performs automated chest compressions. The system can adjust to different patient sizes and can operate in environments with limited space, such as moving vehicles.

The system may be a reasonable alternative to conventional Cardiopulmonary Resuscitation (CPR) in specific settings where the delivery of high-quality manual compressions may be challenging or dangerous for the provider (such as, limited rescuers available, prolonged CPR, during hypothermic cardiac arrest, in a moving vehicle, in the angiography suite, during preparation for ECPR).¹

Intended purpose

AutoPulse NXT is intended to perform automated chest compressions on adult patients in cases of clinical death where chest compressions are likely to help the patient.

Indications for use

The AutoPulse NXT Resuscitation System is intended to be used as an adjunct to manual CPR, on adult patients only, in cases of clinical death as defined by a lack of spontaneous breathing and pulse. The AutoPulse NXT system must only be used in cases where chest compressions are likely to help the patient.

The AutoPulse NXT system is intended for use as an adjunct to manual CPR when effective manual CPR is not possible (e.g., during patient transport or extended CPR when fatigue may prohibit the delivery of effective/consistent compressions to the victim, or when insufficient EMS personnel are available to provide effective CPR).

1. Panchal AR, et al. *Circulation*. 2020;142(suppl 2):S366–S468

Intended users

Users must be familiar with CPR and trained in safe use of the system. Users should be trained in Basic Life Support (BLS) and/or Advanced Life Support (ALS) techniques.

The intended users of AutoPulse NXT are properly trained emergency medical technicians, paramedic, nurse, physician, police, or fire department personnel.

Intended patients

The system is intended for use on patients with the following physical characteristics:

- Chest circumferences between 76 cm and 142 cm (30 in to 56 in)
- Minimum chest width of 25 cm (9.8 in)
- Maximum weight of 181 kg (400 lbs)

System components

The system includes:



Figure 1.1. System components

Number	Description
1	Platform
2	Band
3	Battery and spare battery
4	Battery charger

AutoPulse NXT Platform

The AutoPulse NXT platform (platform), when connected to the band, performs automated chest compressions. Controls and indicators are in the user control panels.

AutoPulse NXT Battery

The AutoPulse NXT battery (battery) supplies power to the platform. The battery can be inserted into the platform or battery charger.

AutoPulse NXT Battery Charger

The AutoPulse NXT battery charger (battery charger) has two charging bays, each with its own indicators.

AutoPulse NXT Band

The AutoPulse NXT band (band), when connected to a platform, performs automated chest compressions. The band is for single use only.

Accessories

Optional accessories include:

- "Quick Case™ Carry Sheet" (page 41)
- "Hygiene Barrier" (page 49)
- "Shoulder Restraint" (page 50)

Clinical Benefits

The primary benefit of AutoPulse NXT is the performance of automated chest compressions as an adjunct to manual CPR.

Mechanical chest compression devices propose a solution to providing chest compressions without interruptions or rescuer fatigue, allowing rescuers to initiate other aspects of care such as transport.

Adjunctive therapies

The AutoPulse NXT system is interoperable with ZOLL technologies.

This page intentionally left blank.

2. Safety Information

This chapter provides information on:

- "Warnings and cautions" (page 5)
- "Symbols" (page 6)

Always follow the warnings, cautions, and notes in this user guide.

Warnings and cautions

This user guide uses the following conventions to indicate important information:

WARNING. Warnings indicate events or conditions that can result in serious injury or death, or severe damage to the equipment.

Caution. Cautions indicate information for safe operation, proper performance, or avoiding actions that can result in damage to the equipment.

WARNING. Compared to manual chest compression recommendations by the American Heart Association (2020 AHA Guidelines for CPR and ECC), the AutoPulse NXT System delivers circumferential adult chest compressions at a lower frequency and, for chest sizes below 10 inches, to a shallower depth of compression. The AutoPulse NXT System's compression rate is 80 ± 5 compressions per minute, and it provides chest displacement equal to a 20% reduction in a patient's anterior-posterior chest depth.

WARNING. The system is intended for use on adults. See "Intended patients" on page 2.

WARNING. When CPR is indicated, start immediately. Do not postpone.

WARNING. Use the system only in cases that manual CPR would normally be initiated. Personnel certified in manual CPR must always be present during system operation.

WARNING. If you are unable to use the system, immediately revert to manual CPR. Patient harm can occur if CPR is delayed. Check the battery charge status (Table 5.1 on page 23) on the "User control panel" (page 10). Replace the battery if needed. If no battery replacement is needed, turn the platform off and on.

WARNING. If the alert indicator is flashing during operation, immediately revert to manual CPR.

WARNING. In the event the platform overheats, check the platform and assess the patient to protect against the potential risk of skin burns.

WARNING. To minimize the impact on run time from high ambient temperatures, store the device in a cool and dry environment.

WARNING. The platform is not intended to be the sole means of carrying the patient. To carry the patient, secure the platform to a transportation device, such as the AutoPulse NXT Quick Case carry sheet, gurney, or backboard. During transport, perform regular checks of the patient's alignment.

WARNING. Do not alter the platform, battery, battery charger, or band.

WARNING. Do not use the system in an atmosphere with greater than 25% oxygen, near flammable liquids or agents (such as gasoline), due to fire hazard.

WARNING. Failure to properly position the edge of the band at the patient's armpit line may result in insufficient compressions and may cause serious internal injuries.

Caution. United States federal law restricts this device to sale by or on the order of a licensed physician.

Caution. The AutoPulse NXT platform, batteries, and battery charger are intended for use together and with ZOLL-approved accessories only. Use of other components may result in increased emissions or decreased immunity of the system, cause permanent damage to the system, and voids the warranty.

Caution. To minimize the risk of electric shock, use the ZOLL-provided power cord and connect to a hospital grade receptacle (in a patient care area) or grounded receptacle (outside of a patient care area), depending on your country's regulations.

Caution. Prior to use, inspect the battery charger for damage to the power cord, power cord pins, or battery charger enclosure. If damage is found, there is risk of electric shock. Discontinue use and contact ZOLL for service.









Caution. Do not immerse the platform, battery, or battery charger in water or other fluids. Fluid immersion or spillage may permanently cause damage or present a fire or shock hazard.











Caution. The system is intended for use by trained professionals.















Caution. Operating the system may result in minor skin abrasions or lacerations to the patient, due to the repetitive motion of the band against the skin.

Note. Any serious incident that has occurred in relation to the device should be reported to the manufacturer and the competent authority of the Member State in which the user and/or patient is established.

Symbols

	AC voltage
	Authorized representative in the European Community/European Union
	Bipolar circuit breaker
	Bluetooth
	Catalog number
	Caution
Rx only	Caution. Prescription use only.
	CE Mark
	DC voltage

	Defibrillation-proof type BF applied part
IP44	Degree of Protection Provided by Enclosure Per IEC 60529
	Dispose of in accordance with local governing ordinances and recycling plans for lithium-ion batteries.
FCC	FCC Declaration of Conformity
	Follow instructions for use
	Consult the instruction for use
	Importer
	Keep away from open flame and high heat.
	Keep dry
	Li-ion battery disposal
LOT	Lot number
	Manufacturer
	Manufacture date

	Country of manufacture
	Medical device
	Non sterile
	Patent
	Quantity
	Rechargeable battery
	Serial number
	Single use only
	Swiss authorized representative
	Temperature limitation
	TUV certification (US, Canada, EU)
	USB
	Li-Ion Battery
	Unique Device Identification

3. Platform

This chapter provides information on:

- "Platform description" (page 9)
- "User control panel" (page 10)
- "Compression mode" (page 12)
- "Mute settings" (page 13)

Platform description

The AutoPulse NXT platform (platform), when connected to the band, performs automated chest compressions. Control and monitor the system with the user control panels. Use the handles to adjust the platform under the patient.

WARNING. Use the handles to carry the platform by itself. Do not use the handles to carry the patient on the platform.

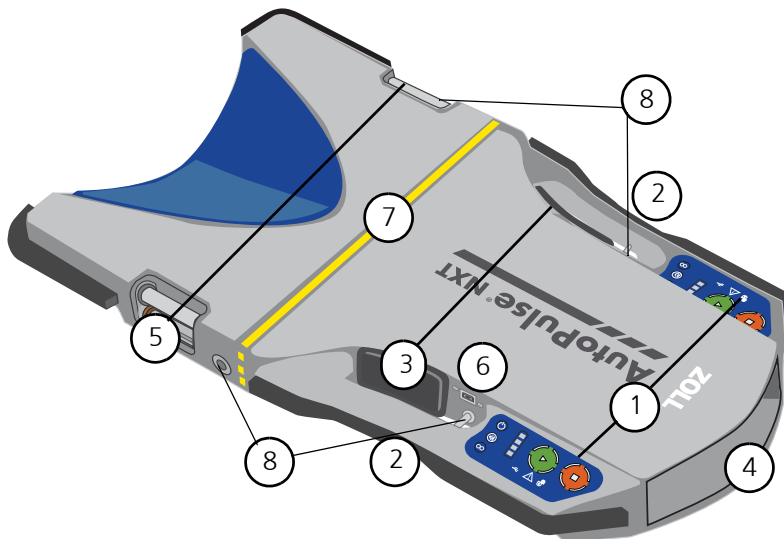

Figure 3.1. Platform

Number	Description
1	User control panels
2	Handles
3	Vents
4	Battery port
5	Guard ports
6	USB port
7	Yellow alignment line
8	Shoulder restraint anchor points

Caution. Do not block the platform vents. If airflow through the vents is obstructed, the temperature of the platform may rise. If the platform overheats, the Alert indicator illuminates and the platform stops compressions, the Start button is disabled and compressions cannot continue. Perform manual CPR until the temperature is within range. See "Platform Environmental Specifications" on page 65.

User control panel

The user control panels enable use and monitoring of the system. There is one user control panel for each side of the platform. If one user control panel does not work, use the other user control panel.

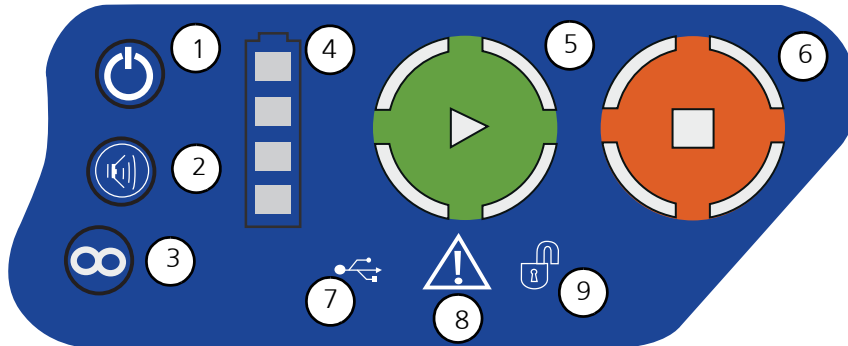

Figure 3.2. User control panel

Number	Name	Color	Indicator	Action
1	Power	Green	Illuminated when on.	<ul style="list-style-type: none"> Press to turn the platform on or off. If the platform does not turn off, press and hold the button for four seconds or more. Data loss may occur and the band may not loosen. If the band does not loosen, turn the power back on or see "Retracting bands" on page 62.
2	Mute	Green	Illuminated when muted.	Press to mute the beeps. See "Mute settings" on page 13.
3	Compression Mode	Green	<ul style="list-style-type: none"> Illuminated when Continuous mode is selected. Not illuminated when 30:2 mode is selected. 	Press to change the "Compression mode" (page 12).

Table 3.1: User control panel

Number	Name	Color	Indicator	Action
4	Battery charge status	Green	<p>Mimics the battery indicator, See "Battery status" on page 22.</p> <ul style="list-style-type: none"> When there are five minutes of charge remaining, there are 4 beeps. Every 30 seconds thereafter, there are double beeps until the power runs out. If the battery is too low to perform compressions, the Alert light flashes and compressions stop. When 10% or less of charge remains the bottom bar on the battery charge indicator flashes. 	Indicator only
5	Start	Green	Illuminated during compressions	Press to start compressions.
6	Stop	Red	Illuminated before compressions start or when compressions stop	<ul style="list-style-type: none"> Press once to stop compressions. The band loosens. The platform beeps. See page 36. Press again to stop the beeps. After 15 minutes with no button presses, the platform automatically turns off. Press again to delay the platform automatically turning off for an additional 15 minutes.
7	USB	Green	<ul style="list-style-type: none"> Flashing when transferring performance report summary files (page 40) from the platform to a USB drive. Illuminated when transfer from the platform to a USB drive is complete. 	Indicator only
8	Alert	Yellow	Illuminated but compressions can continue	Continue to use the platform and contact "Technical Support" (page 58) afterwards.
			Illuminated but the platform does not compress	See "Solid alert indicator" on page 61.
			Flashing and the Battery charge status is flashing one bar	Replace the battery.
			Flashing and the Battery charge status is not flashing	Turn off and then turn on the platform. If that does not clear the error, revert to manual compressions and contact Technical Support (page 46).

Table 3.1: User control panel (Continued)

Number	Name	Color	Indicator	Action
9	Band guard lock indicator	Red	<ul style="list-style-type: none"> Flashing on one user control panel if the band guard on that side is not correctly installed on the platform. The light is solid on the other user control panel. Flashing on both user control panels if the band guards on both sides are not correctly installed on the platform. <p>Note. If either indicator is flashing, the Start button is disabled.</p> <p>Note. Compressions stop if a band guard detaches from the platform.</p>	Indicator only

Table 3.1: User control panel (Continued)

Compression mode

The system has two compression modes: 30:2 and Continuous. See Table 3.1.

The 30:2 mode compresses the patient 30 times and then pauses for three seconds to allow you to administer ventilation. The platform beeps at the 28th, 29th, and 30th compression to signal that the ventilation pause is coming up.

During Continuous mode, the platform does not pause. The platform beeps at the start of every eighth compression, guiding ventilations at a rate of 10 breaths per minute.

Changing the compression mode

The factory default compression mode is 30:2.



Figure 3.3. Compression Mode button

To change the compression mode for the current session

1. Ensure the platform is on.
2. Check the default compression mode:
 - When the default compression mode is 30:2, Compression Mode is not illuminated.
 - When the default compression mode is Continuous, Compression Mode is illuminated.
3. Press and release Compression Mode. The platform beeps once.
4. To change the compression mode back, press and release Compression Mode again.

Note. When the platform turns off, the compression mode reverts to the default compression mode.

To configure the default compression mode

The default compression mode is active when the platform is turned on. Configure the default compression mode when you are setting up the platform.

1. Ensure the platform is on.
2. Check the default compression mode:
 - When the default compression mode is 30:2, Compression Mode is not illuminated.
 - When the default compression mode is Continuous, Compression Mode is illuminated.
3. To change the default compression mode, press the Compression Mode button until the platform beeps once, then release.
4. Press and hold Compression Mode button. The platform beeps once. Hold for at least 4 seconds until the platform beeps again, then release.

Mute settings

Press Mute to silence ventilation, pause, and low battery beeps for 30 seconds.

If mute is activated, the beeps resume when:

- 30 seconds have passed.
- You press Mute again.

This page intentionally left blank.

4. Band

This chapter provides information on:

- "Band description" (page 15)
- "Installing the band" (page 16)
- "Removing the band" (page 19)

Band description

The AutoPulse NXT Band (band) is a load-distributing band that includes two belts with guards to install on the platform. Connected to the platform, the band automatically adjusts to the patient's size and provides compressions to the patient's chest. The latex-free band is for single use only.

Caution. Use care while using sharp instruments around the band. Do not use the band if any cuts or tears are present.

Caution. The band guard contains a small magnet. Keep the band guard at least two inches (6 cm) away from ICDs or pacemakers to prevent the possibility of the ICDs or pacemakers entering magnet mode.

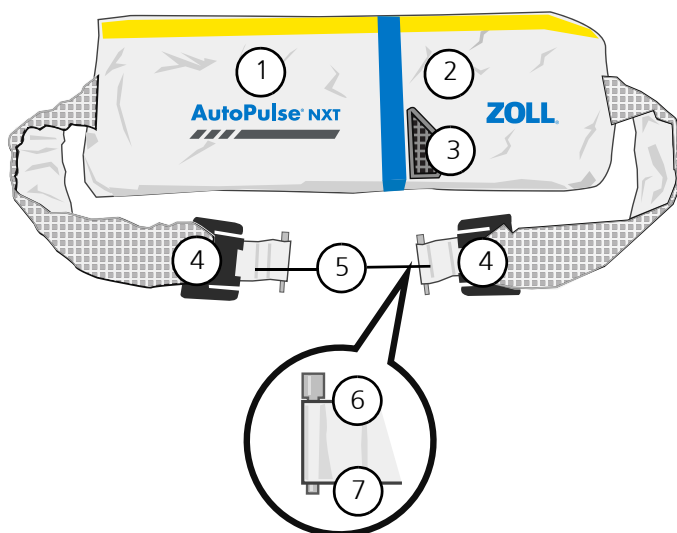
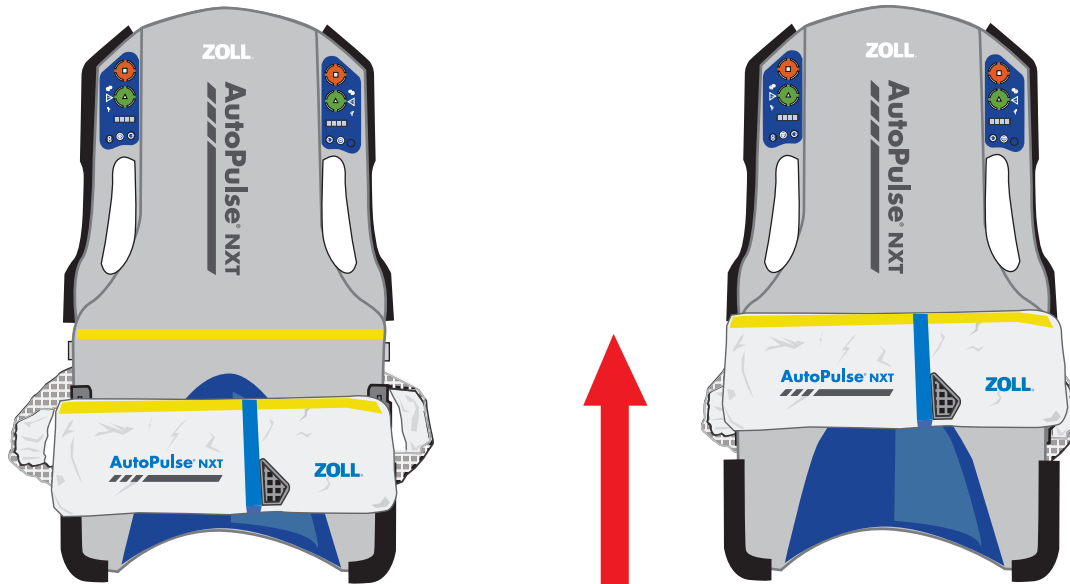

Figure 4.1. Band

Number	Description
1	Band (short side)
2	Band (long side)
3	Grip
4	Band guards
5	Belt
6	Pin (large end)
7	Pin (small end)

Installing the band

1. Place the platform, with the patient surface facing up, on a smooth, flat surface.
2. Place the band on top of the platform. Align the yellow lines on the band and platform.



3. Starting on one side of the platform, orient the band in a U shape, with no twists.
Caution. Performing compressions with a twisted band may cause skin abrasions or lacerations to the patient.

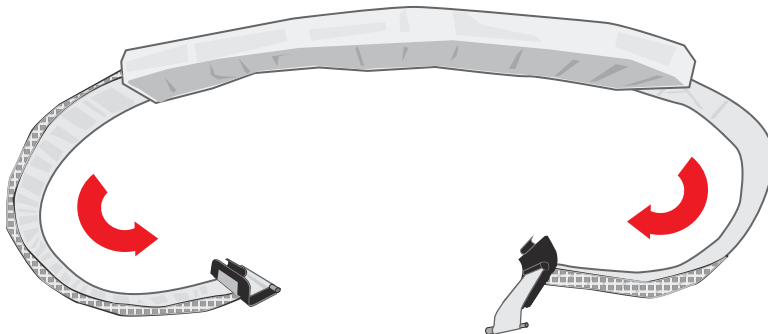

4. In the guard port on the platform, check that the spool is oriented so that the slot is facing outward.
Caution. Before inserting your fingers into the guard port, ensure that the spools are not moving.

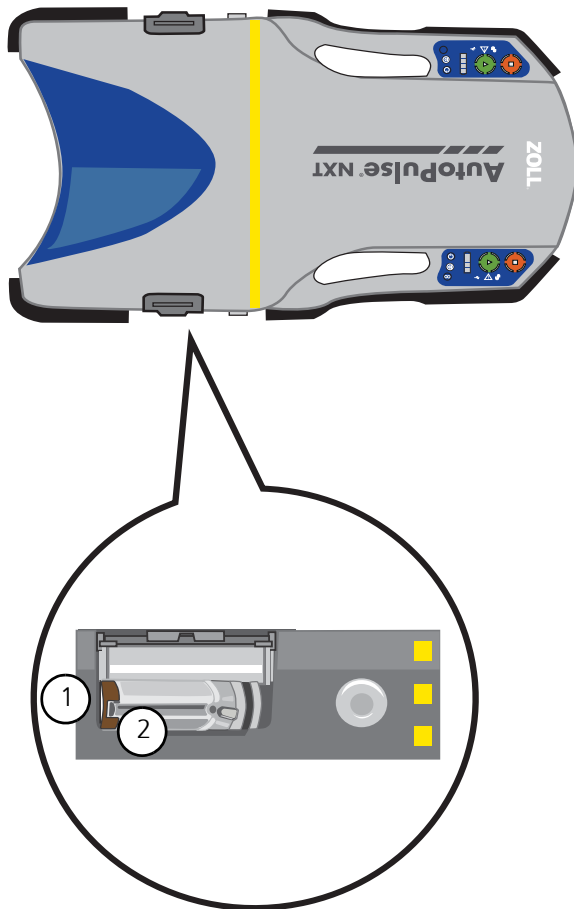
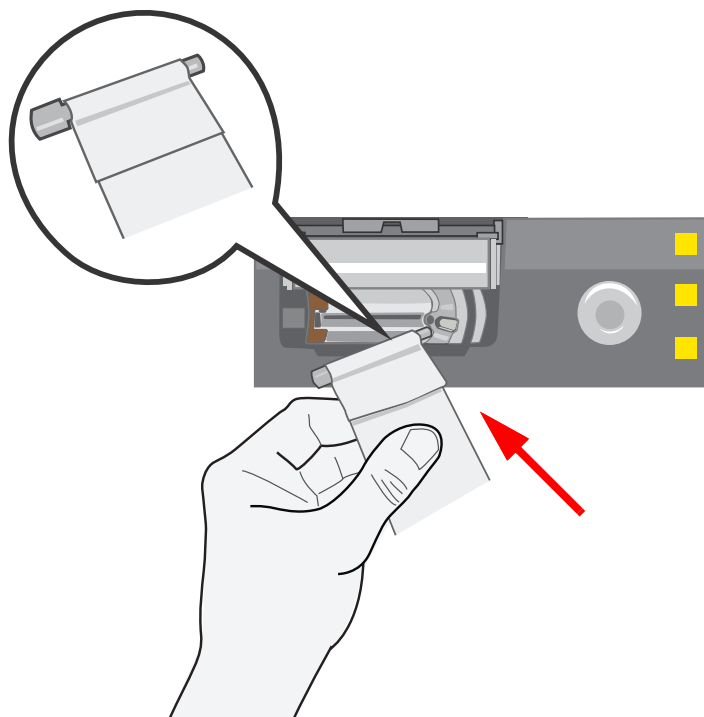

Figure 4.2. Platform spool

Number	Description
1	Release
2	Slot

5. Hold the bottom of the band with the small end of the pin facing the yellow line.



6. Insert the small end of the pin into the hole closest to the yellow line.

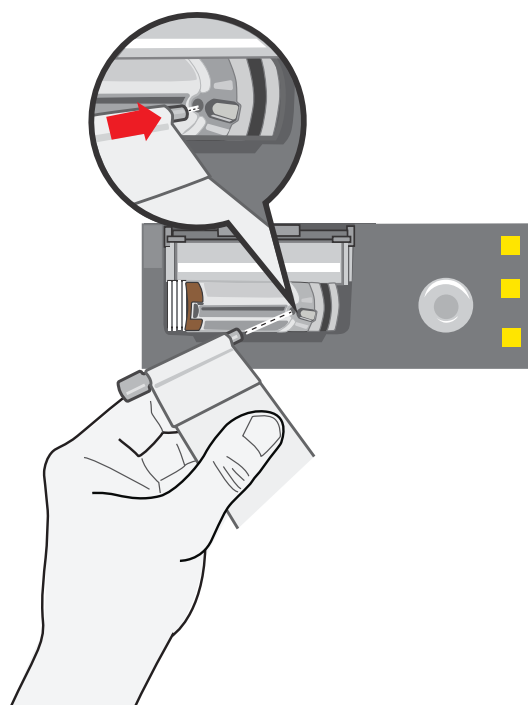

7. Insert the large end of the pin into the opposite hole. With your fingers under the band, press in the pin and snap into place.

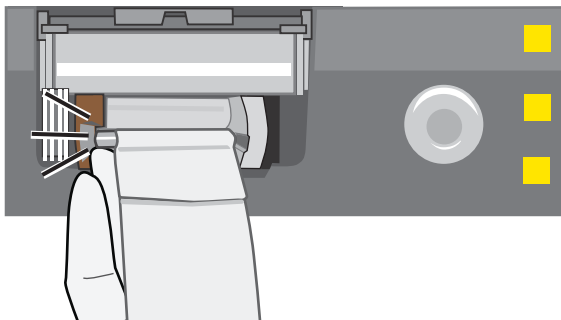

8. Insert the short side of the band guard into the top of the guard port.

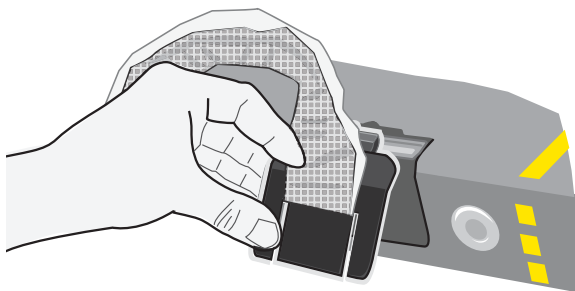

9. Push the long side of the band guard into the bottom of the guard port.
10. Push the short side of the band guard again, fully snapping the band guard into the guard port.

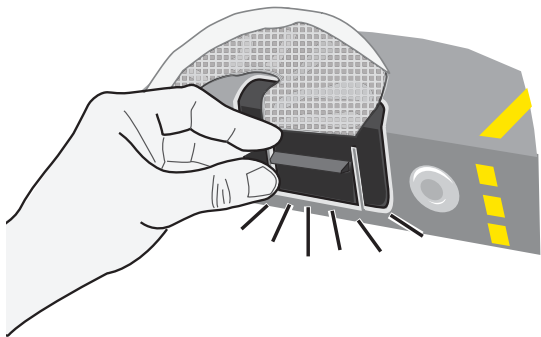

11. Repeat Step 3 through Step 10 on the other side of the platform.
12. Turn on the platform.
 - Note.** If the band retracts into the platform, see "Retracting bands" on page 62.
13. Check the band guard lock indicators on the "User control panel" (page 10) are not flashing. If either band guard lock indicator is flashing, check that the band guard is correctly installed on the platform.

Removing the band

Caution. Do not cut the band before removing from the platform. See "Cut bands" on page 61.

1. Place the platform, with the patient surface facing up on a smooth, flat surface.

2. Push the bottom (long side) of the band guard up and lift it out of the guard port.

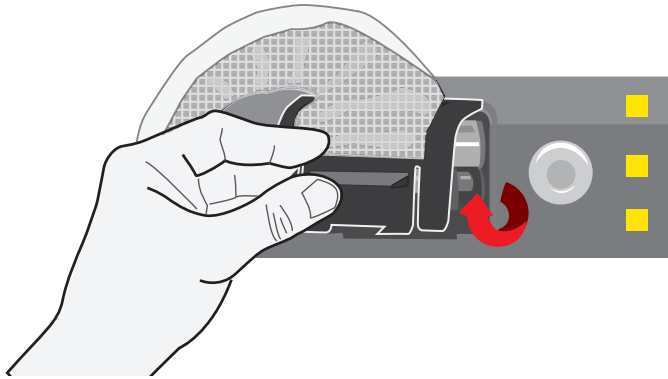

3. Press the platform release away from the yellow line to release the pin.



4. Remove the pin.
5. Pull on the band to remove it from the platform.

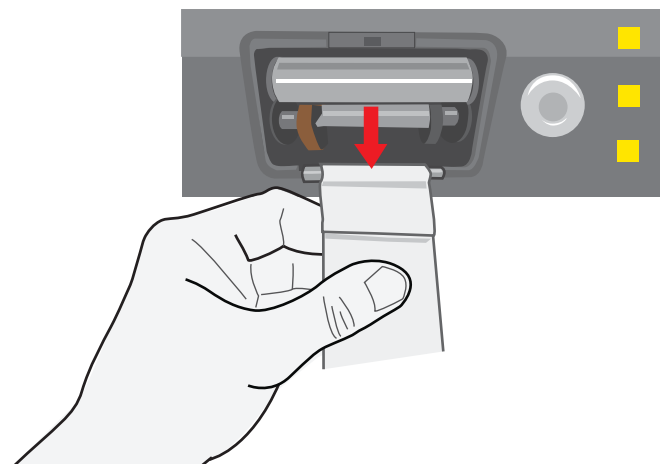

6. Repeat Step 2 through Step 5 with the other side of the band.
7. Discard the band as biohazard waste.

5. Battery

This chapter provides information on:

- "Battery description" (page 21)
- "Handling new batteries" (page 22)
- "Battery status" (page 22)
- "Installing and removing the battery" (page 23)
- "Expected battery life" (page 23)

Battery description

The AutoPulse NXT battery (battery) is a proprietary, rechargeable, removable lithium-ion battery that is the power source for the platform.

WARNING. Always charge a stored battery before placing the battery in active operation. Check the "Battery status indicators" (page 23). Do not use batteries that have not been charged for longer than a month without charging them first. See "Battery charger measurement cycle" on page 30.

Caution. The battery is mechanically keyed to the platform and battery charger to facilitate correct installation. Do not force a connection if you cannot easily connect the battery to either the platform or battery charger. Doing so may result in damage to the battery, platform, or battery charger. If resistance is met, check for the appropriate orientation and for any obstructions.

Caution. Always inspect the battery for damage prior to insertion into either the platform or battery charger. Never place a damaged battery into the platform or battery charger. If damage to a battery is found, contact "Technical Support" (page 58).

Caution. Do not short the battery leads. Electrical connection (short) between the battery power leads on the connector can damage the battery and render it inoperable.

Caution. Do not leave the battery in direct sunlight for an extended time.

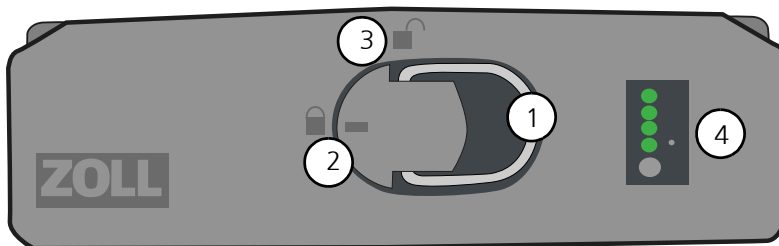

Figure 5.1. Battery

Number	Description
1	Finger ring
2	Locked position (Figure 5.1, "Battery," on page 21)
3	Unlocked position (Figure 6.4, "Removing the battery from the battery charger," on page 28)
4	Battery status indicator (Table 5.1 on page 23)

Handling new batteries

For safety and prolonged shelf life, batteries are shipped at a reduced state of charge and cannot be used in the platform without charging.

Before using a new battery, charge the battery in the battery charger. The battery charger brings batteries out of low power storage mode, charges, and when needed, automatically performs a measurement cycle and test. See "Battery charger measurement cycle" on page 30.

Note. Batteries must be charged before first use, and at least once a year thereafter.

Battery status

If the battery is not in the battery charger, press the Status check button to view the battery charge level (Figure 5.2). If the battery is in the battery charger, the battery charge status is displayed in the "Battery charger panel" (page 29).

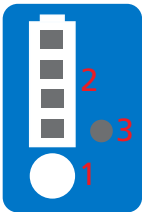

Figure 5.2. Battery status

Number	Description
1	Status check button
2	Charge indicator
3	Alert indicator

Battery status indicator	Color	Definition	Action	
Charge indicator	Green	4 bars	The battery has over 75% charge.	The battery is ready for use in the platform.
		1–3 bars	The battery has a partial charge.	The battery may be used in the platform, but should be charged. If the battery has been recently charged, it may be near end-of-life. Contact "Technical Support" (page 58).
	Green flashing	1 bar	The battery has a very low charge.	Charge the battery.
Alert indicator	Red	The battery has failed and cannot be used.	See "Disposal" on page 55.	
None	None	The battery cannot be used (see page 21).	Charge the battery.	

Table 5.1: Battery status indicators

Installing and removing the battery

To install the battery into the platform:

1. Make sure the battery compartment in the platform is clear of debris or obstructions.
2. Slide the battery into the battery compartment. Ensure the battery is fully seated:
 - The battery should snap into place.
 - The battery should be flush with the platform.
 - When the battery is pulled by the metal ring, the battery should not come out. (Do not rotate the ring when pulling).

To remove the battery from the platform:

1. Lift the finger ring and rotate it clockwise to the unlocked position.
2. Hold the platform firmly and pull the battery straight out until it fully clears the battery compartment.

Expected battery life

Service life of a properly maintained battery with typical use is five years. The battery capacity decreases with use over this time. As a preventive measure, ZOLL recommends replacing batteries at least every five years regardless of the battery's capacity. ZOLL also recommends purchasing batteries at intervals to eliminate the need to replace all batteries at the same time.

Note. When the battery no longer charges to four bars consistently, it has reached the end of its service life and should be replaced.

This page intentionally left blank.

6. Battery Charger

This chapter provides information on:

- "Battery charger description" (page 25)
- "Setting up the battery charger" (page 27)
- "Using the battery charger" (page 27)
- "Battery charger panel" (page 29)
- "Battery charger measurement cycle" (page 30)

Battery charger description

The AutoPulse NXT battery charger (battery charger) is used to charge, test, and maintain up to two AutoPulse NXT batteries. The battery charger has two charging bays, each with its own indicators. When in use, the battery charger continuously tests itself and any batteries in its bays.

Properly maintain and fully charge batteries so that they are ready for use before deploying the system.

WARNING. To avoid the risk of electric shock, connect the battery charger only to a supply main with protective earth.

Caution. Do not use the battery charger in a vehicle.

Caution. Do not block the vents on the bottom and back of the battery charger.

Caution. Do not operate the battery charger in a confined space.

Caution. Do not position the battery charger so that it is difficult to unplug the power cord.

Caution. Keep the battery charger away from moisture.



Figure 6.1. Battery charger (front)

Number	Description
1	Charging bays
2	"Battery charger panel" (page 29)

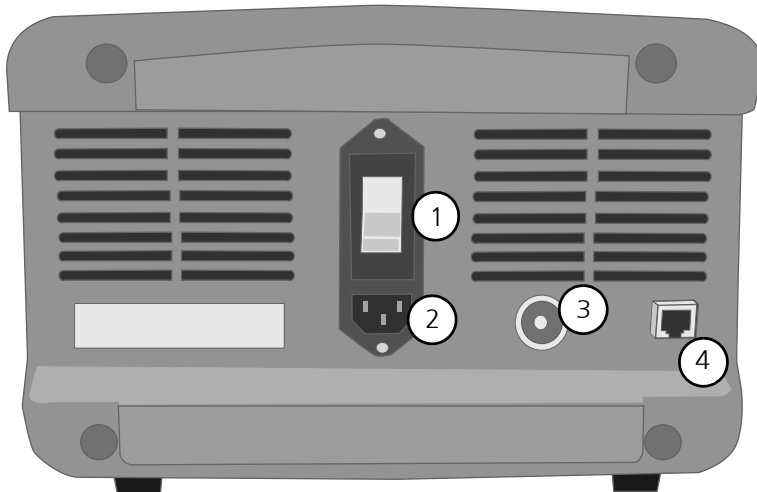

Figure 6.2. Battery charger (back)

Number	Description
1	Circuit breaker
2	Power port
3	Potential equalization port
4	Ethernet port

Setting up the battery charger

To prepare the battery charger for use:

1. Make sure the circuit breaker on the back of the battery charger is on and remains on. Do not turn off.
2. Plug the power cord into the power port on the back of the battery charger.
3. Plug the power cord into a wall electrical outlet.

When the battery charger is first plugged in, all indicators on the battery charger's control panel illuminate briefly and the power indicator remains illuminated. See "Battery charger panel" on page 29.

Note. If the indicators do not illuminate, check the power cord and circuit breaker. If the battery charger alert indicator illuminates, see Table B.2, "Battery charger troubleshooting," on page 64. If all indicators remain illuminated, contact "Technical Support" (page 58).

To remove power from the battery charger, unplug the power cord from the wall electrical outlet. For the locking power cord, press the red button before unplugging.

Using the battery charger

To maximize battery capacity and life, charge at operating temperatures (Table C.5 on page 67). If possible, charge the battery at room temperature [10°C (50°F) to 30°C (86°F)]. For optimal charging, the battery should be at room temperature before inserting into the battery charger. If the battery's internal temperature is out of range (Table C.5 on page 67), the battery does not charge. The status indicator on the battery charger blinks very slowly until the battery is within the temperature range.

Charging the battery

To charge the battery:

1. Make sure the charging bay is clear of debris or obstructions.
2. Insert the battery, connector first, into the charging bay until it properly latches into position (Figure 6.3).
Caution. Do not slam the battery into the battery charger. This may cause damage to the battery and battery charger.

The battery charger automatically detects the battery and starts the charge cycle.



Figure 6.3. Batteries in the battery charger

Removing the battery

To maximize the battery's charge, do not remove the battery from the battery charger until charging completes. See Table 6.1 on page 30.

To remove the battery:

1. Pull out the finger ring and rotate clockwise to the unlock position.
2. Pull the battery out of the battery charger.

Note. Newly-charged batteries can be warm to the touch. This is normal.

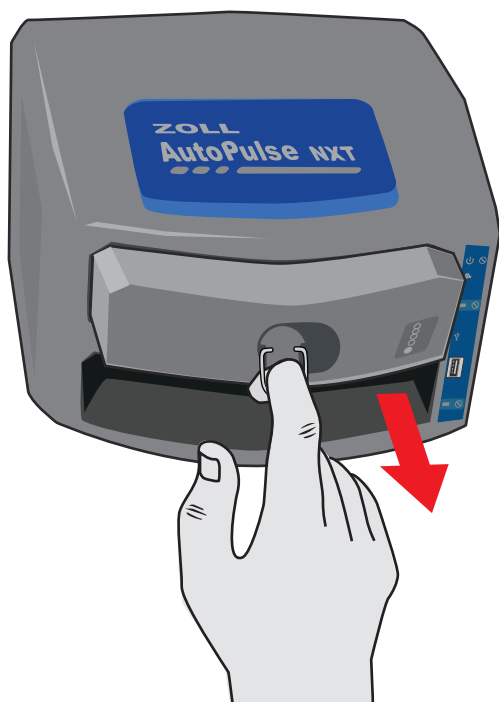

Figure 6.4. Removing the battery from the battery charger

Battery charger panel

The battery charger panel shows status for the battery charger and the battery in each bay.

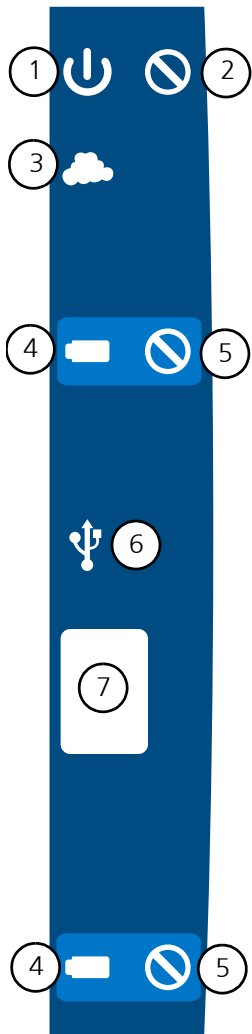

Figure 6.5. Battery charger panel

Number	Description
1	Power. Illuminated when the battery charger is on.
2	Battery charger alert. Illuminated if the battery charger is on but requires attention. See “Troubleshooting the battery charger” on page 64.
3	Cloud. Not available at this time.
4	Battery charge status. Illuminated for the battery in the applicable bay.
5	Battery alert. Illuminated if the battery in the applicable bay is not working.
6	USB transfer status. Not available at this time.
7	USB port. To access log files (Service only).

Mode	Battery charger indicator	Definition	Action
Charging	The battery charge status indicator flashes at a fast rate.	The battery is charging. Typical charge time is up to 2 hours.	Leave the battery in the battery charger. The battery charge indicator shows the charge level. See "Battery status" on page 22.
Measurement cycle	The battery charge status indicator flashes at a slow rate.	The battery is undergoing a measurement cycle.	Leave the battery in the battery charger until the measurement cycle completes. See "Battery charger measurement cycle" on page 30.
Out of temperature range		The battery is either above or below the temperature range.	Remove the battery from the battery charger until the temperature returns to range. Reinsert the battery into the battery charger. See "Using the battery charger" on page 27.
Ready	The battery charge status indicator remains illuminated.	The battery is fully charged and is ready to use.	Do one of the following: <ul style="list-style-type: none"> • Leave the battery in the battery charger to ensure a full charge when needed. • Install the battery in the platform. • Store the battery in a cool dry place.
Fail	The battery alert indicator illuminates.	The battery charger was unable to charge the battery or the battery has failed the measurement cycle.	Remove and reinsert the battery into the battery charger. If the battery alert remains illuminated, note the battery serial number and contact "Technical Support" (page 58).
Idle	Neither the battery charge status indicator nor the battery alert indicator illuminate.	The battery charger is unable to recognize the battery.	Remove and reinsert the battery. If the status is still Idle, see "Troubleshooting the battery charger" on page 64.

Table 6.1: Battery charger status indicators

Battery charger measurement cycle

The measurement cycle measures a battery's capacity. If a battery has not undergone a full charge/discharge cycle and is placed in the battery charger, a measurement cycle is automatically initiated.

The measurement cycle can take 5 to 10 hours. Do not remove the battery from the battery charger until the measurement cycle is complete, or the battery's charge may be reduced. If the battery is removed before the measurement cycle is complete, the next time the battery is inserted into the battery charger, the measurement cycle automatically restarts.

After the measurement cycle completes, the battery is either ready to use (battery charge status indicator on the battery charger panel illuminates) or has failed and should be replaced (battery alert indicator on the battery charger panel illuminates).

If a battery has failed the measurement cycle, do not use it. Contact "Technical Support" (page 58).

Battery charger circuit breaker

If the alternating current (AC) mains power circuit breaker has tripped (You hear a click when the cord plugged in, and the circuit breaker is not fully in the on position):

1. Unplug the power cord from the wall electrical outlet. Wait one minute.
2. Turn off the circuit breaker. See Figure 6.2, "Battery charger (back)," on page 26.
3. Turn on the circuit breaker.

This page intentionally left blank.

7. Using the System

This chapter provides information on:

- "Required materials" (page 33)
- "Setting up the system" (page 33)
- "Deploying the system" (page 33)
- "Operating the system" (page 34)
- "Patient alignment and securing for transport" (page 37)
- "Patient extrication" (page 37)
- "Periodic Electrocardiogram (ECG) Monitoring and/or Defibrillation" (page 38)
- "Ending treatment" (page 38)
- "Preparing for next use" (page 38)
- "AutoPulse NXT Performance Report" (page 39)
- "Downloading the AutoPulse NXT performance report" (page 40)

Required materials

The following are required for each treatment session:

- Platform
- Battery
- Band

Note. Always carry at least one spare band and battery.

Setting up the system

To prepare the system for use:

1. Inspect the platform for visible damage.
2. Ensure the "Battery status indicators" (page 23) show four bars, a fully charged battery.
3. Install the band on the platform. See "Installing the band" on page 16.
4. Insert the battery into the platform. See "Installing and removing the battery" on page 23.
5. Turn on the platform.
6. Check that the alert indicator on the user control panel is not illuminated or flashing. See "Troubleshooting the platform" on page 61.

Deploying the system

In order to deploy the system quickly and with the least interruption in cardiac compressions, a pit crew model similar to that which is used in auto racing – is suggested for the roles and positions of users performing compressions and using the system. Your ZOLL representative can provide appropriate instructions based on the setting where you work (EMS or hospital) and the number of clinicians who typically deal with sudden cardiac arrest. Each organization should determine how this type of model can be integrated into the roles performed by its resuscitation team. Practice as a team using this model to streamline actions and ensure rapid, efficient deployment.

Average deployment time from manual CPR to mechanical CPR is five seconds.

Operating the system

Note. Perform manual CPR until the patient is on the platform.

WARNING. Compared to manual chest compression recommendations by the American Heart Association (2020 AHA Guidelines for CPR and ECC), the AutoPulse NXT System delivers circumferential adult chest compressions at a lower frequency and, for chest sizes below 10 inches, to a shallower depth of compression. The AutoPulse NXT System's compression rate is 80 ± 5 compressions per minute, and it provides chest displacement equal to a 20% reduction in a patient's anterior-posterior chest depth.

Caution. Two hours prior to deployment, keep the platform (with battery) at operating temperatures (Table C.3 on page 65). If the platform is deployed outside this temperature range, it may not start or may shut down during operation. The platform can operate when it returns to this temperature range. To maximize run time, keep the platform between the preferred operating temperatures (Table C.3 on page 65). If the platform does not operate, perform manual CPR.

To use the system:

1. Position the platform at the patient's head.
2. Turn on the platform.
3. Open the band, pulling the grip diagonally.

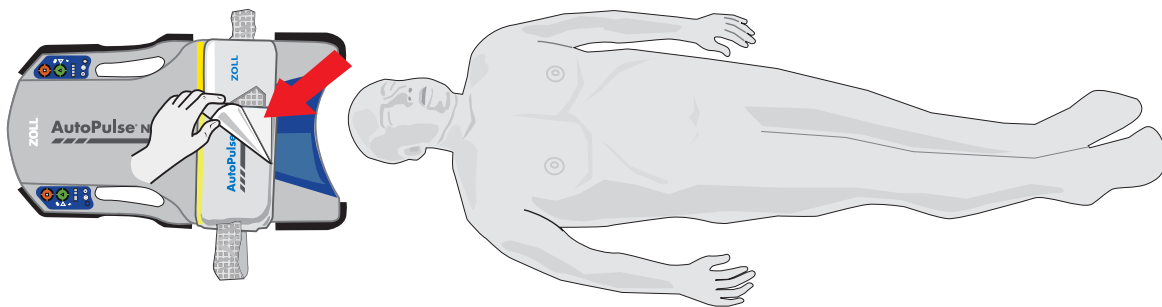

4. Place the band parallel to the platform.

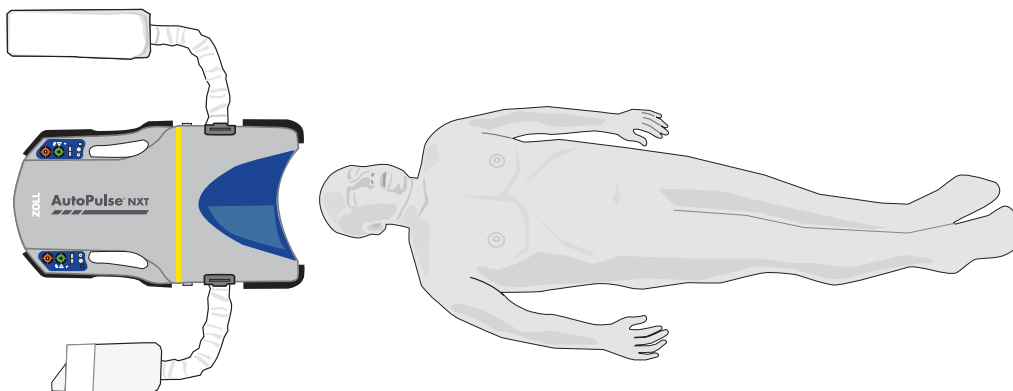

- Sit the patient up.

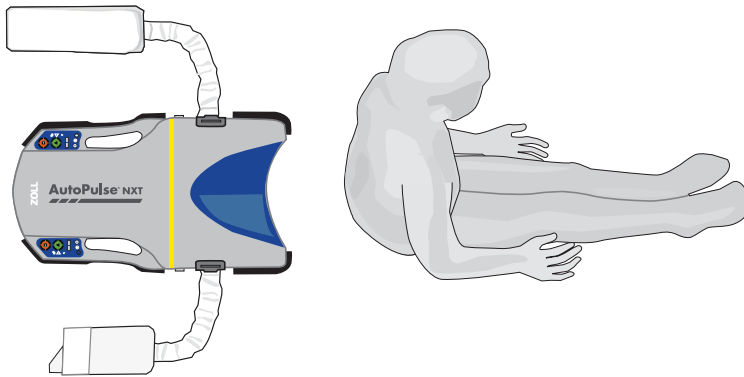

- Slide the platform under the patient.

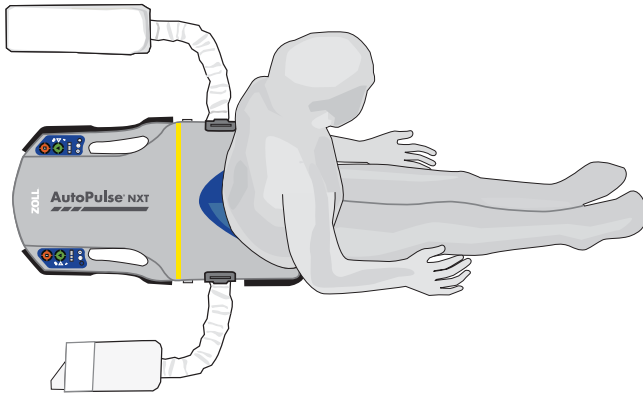

- Lower the patient onto the platform. Position the patient's armpits to align with the yellow line on the platform.

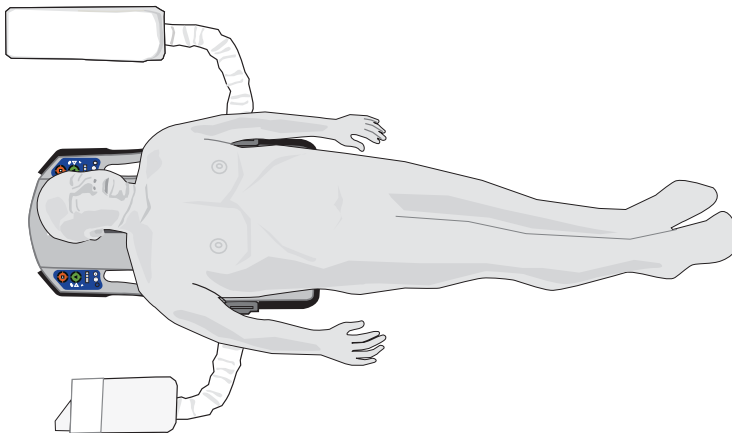

- Place the long side of band on the patient's chest with the yellow line aligned with the patient's armpits.

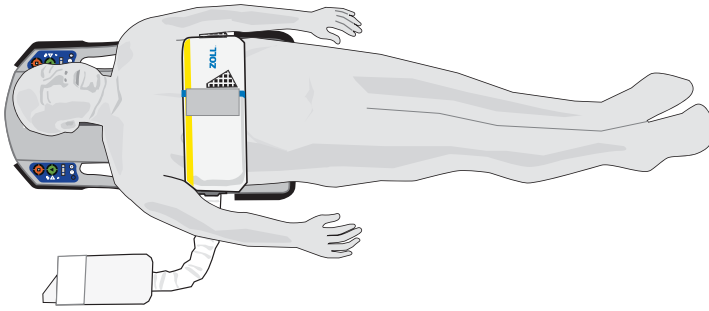

- Place the short side of the band on top of the long side of band.
- Line up the edges of the blue lines on the long and short sides of the band. Press firmly to attach.

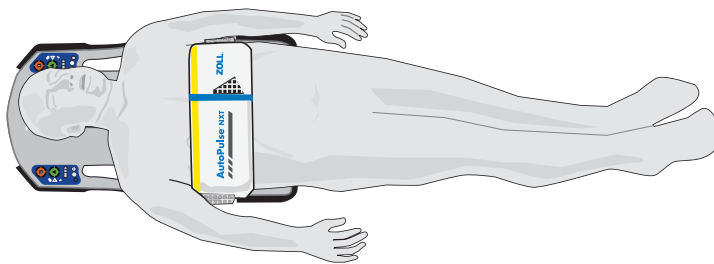

- Press Start.

The system analyzes the patient's chest size and begins compressions.

Caution. Before compressions begin, make sure that the band is not twisted.

WARNING. Failure to correctly position the patient on the platform may cause injury to the patient.

WARNING. Do not touch the patient while the system is analyzing the patient's size.

WARNING. Press Stop to pause compressions before moving or realigning the patient. Press Start to continue compressions.

WARNING. Do not place a strap across or otherwise constrain the movement of the band.

WARNING. Check the patient's chest rise while ventilating during system operation.

Note. Positive pressure ventilation can be performed synchronously at any decompression and/or during a ventilation pause.

Note. Opening the band during active operation causes the system to stop operation immediately. To restart compressions, refasten the long and short sides of the band, press Start.

- To pause compressions, press Stop. The band loosens.

Note. When the platform is paused, it beeps once after 10 seconds, twice after 20 seconds, three times after 30 seconds, four times after 40 seconds, five times after 50 seconds, and continuously after 60 seconds. Press Mute to temporarily silence the beeps. See "Mute settings" on page 13.

Note. Press Stop twice to end the beeps. The band is ready for removal from the platform. See "Ending treatment" on page 38.

- To restart compressions, press Start.

Patient alignment and securing for transport

The platform is not intended to carry or transport a patient. To carry or transport the patient, secure the platform to a transportation device such as the Quick Case carry sheet, gurney, or backboard. During transport, regularly check the patient's alignment.

The patient can be secured to a transportation device and carried while the platform is performing active compressions.

The platform does not require any patient restraints to perform compressions while the patient is lying on a flat surface. However, patient restraints should be used to maintain alignment of the patient to the platform:

- If the platform cannot be set on a flat level surface
- If the platform is used during extrication or during transport

The platform is designed to be used with the accompanying accessories for securing the patient and maintaining patient alignment.

Caution. Motion can cause the patient to shift and restraints to loosen, so make sure the alignment is correct when strapping the patient to the platform. During active compressions, regularly check patient alignment to the platform and band alignment to the patient's mid-axillary line.

When transporting the patient, secure the patient and the platform to a transportation device using locally-approved procedures for safe transport.

Caution. Do not use the platform alone to transport the patient.

Caution. Straps or restraints must not alter the alignment of the patient to the platform or interfere with operation of the platform. Ensure that compression and full decompression of the chest is not restricted in any way.

Patient extrication

This extrication method includes the "Shoulder Restraint" (page 50) and "Quick Case™ Carry Sheet" (page 41).

1. Attach the shoulder restraint to keep the patient properly aligned on the platform.
2. Attach the platform to a transportation device such as the Quick Case carry sheet or backboard.

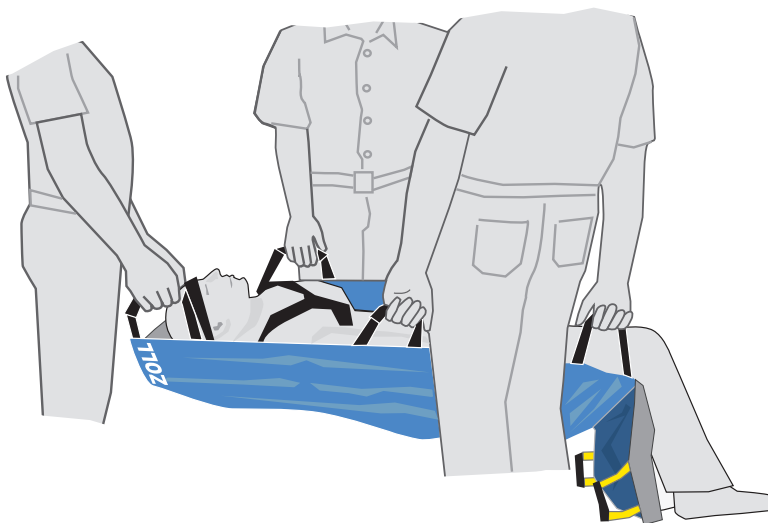

Note. When lifted, the Quick Case carry sheet cradles and helps maintain alignment of the patient on the platform. You can allow the patient's knees to bend freely, facilitating moving around tight corners and stairwells.

Always ensure:

- The patient's armpits and the upper edge of the band are aligned with the yellow line on the platform.
- The band is not twisted.
- The long and short sides of the band are firmly attached.
- The band is positioned at 90 degrees with the platform.
- Ensure that the band is not impeded by anything such as the patient's arms, clothing, straps, and buckles that may interfere with the movement of the band.

Periodic Electrocardiogram (ECG) Monitoring and/or Defibrillation

When the platform is used in conjunction with defibrillators or with other therapeutic devices that must monitor an ECG signal, interruption of the compression cycles may be required to avoid ECG motion artifacts associated with mechanical chest compressions.

To temporarily interrupt the platform's active operation, press the Stop button (Figure 3.2, "User control panel," on page 10). To restart the platform, press the Start button (Figure 3.2, "User control panel," on page 10).

Ending treatment

To end treatment:

1. Press Stop twice.
2. Remove the band from the patient.
3. Turn off the platform.

Preparing for next use

To prepare the system for next use:

1. Remove the band from the platform. See "Removing the band" on page 19.
2. Remove the battery.
3. Clean the battery. See "Cleaning the battery" on page 54.
4. Charge the battery. See "Batteries in the battery charger" on page 27.
5. Clean the platform. See "Cleaning the platform" on page 54.
6. Install a new band. See "Installing the band" on page 16.
7. Insert a fully charged battery.

The battery charge status should display four bars. If not, replace the battery with a fully charged battery before use.

AutoPulse NXT Performance Report

A session is considered the time from when the platform turns on to when it turns off. A performance report summary file provides data from the session. The performance report file can be downloaded from the platform to a FAT-32-formatted USB drive and viewed in PDF format.

The AutoPulse NXT Performance Report files include:

- Summary date. Date the summary was generated
- Product version
- Platform serial number
- Preventive Maintenance due date
- Battery serial number
- Power on time. Time the platform was turned on
- Session start time. Time compressions started
- Session stop time. Time compressions ended
- Duration in minutes. Session duration in minutes
- Ventilation mode. 30:2 or Continuous
- Compression rate. Compressions per minute (cpm)
- Compression count. Number of compressions performed during the session
- Compression fraction. Percent of session time spent performing compressions
- Number of pauses. Number of time compressions were stopped during the session
- Total pause time
- Status Code. Reason for any alerts
- Events. Time and description of events that trigger an alert

Downloading the AutoPulse NXT performance report

1. Ensure the battery is installed in the platform.
2. Turn on the platform.
3. Insert a USB drive into the USB port.

Note. The USB indicator on the user control panel should start flashing.



4. Wait until the USB indicator stops flashing and remains illuminated.
Caution. To avoid damage to the USB drive, do not remove the USB drive while the USB indicator is flashing.
5. Remove the USB drive.
6. The USB indicator turns off.
Note. Time is reported as UTC time.

8. Accessories

This chapter provides information on:

- "Quick Case™ Carry Sheet" (page 41)
- "Hygiene Barrier" (page 49)
- "Shoulder Restraint" (page 50)

Quick Case™ Carry Sheet

The AutoPulse NXT Quick Case™ carry sheet is exclusively for use with the AutoPulse® NXT Resuscitation System. The Quick Case carry sheet is designed to protect the platform during storage and to transport the platform and patient while the platform is in use.

Note. Prior to use, check the Quick Case carry sheet for any damage.



Figure 8.1. Quick Case carry sheet

Height	226 cm (89 in)
Width	108 cm (42.5 in)
Weight	2.5 kg (5.5 lbs)

Table 8.1: Open layout dimensions

Height	76 cm (30 inches)
Width	44.5 cm (17.5 inches)
Depth	127 cm (5 in)

Table 8.2: Closed layout dimensions with platform

Patient Safety

The carry sheet may be used only after consulting the Instructions for Use and only by qualified personnel.

To exclude defects due to usage, examine the fabric for visible damage before each use.

ZOLL assumes no responsibility for damage caused by improper handling by unauthorized persons or for wear and tear on the material.

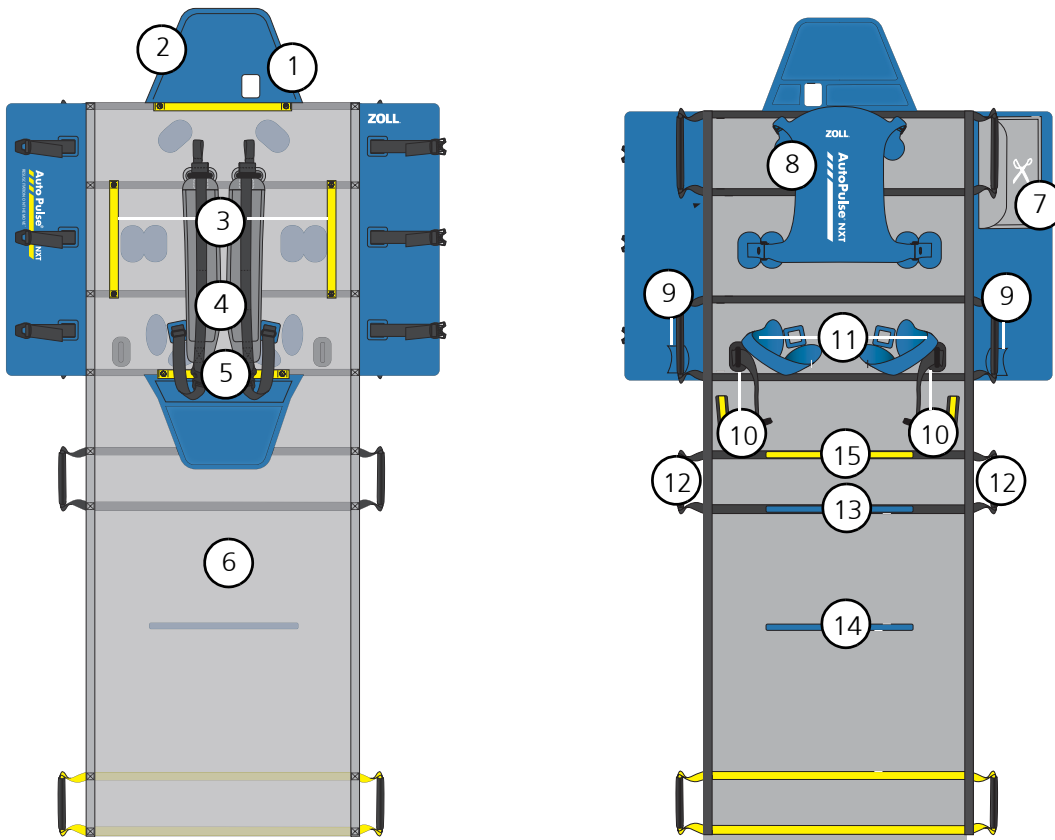
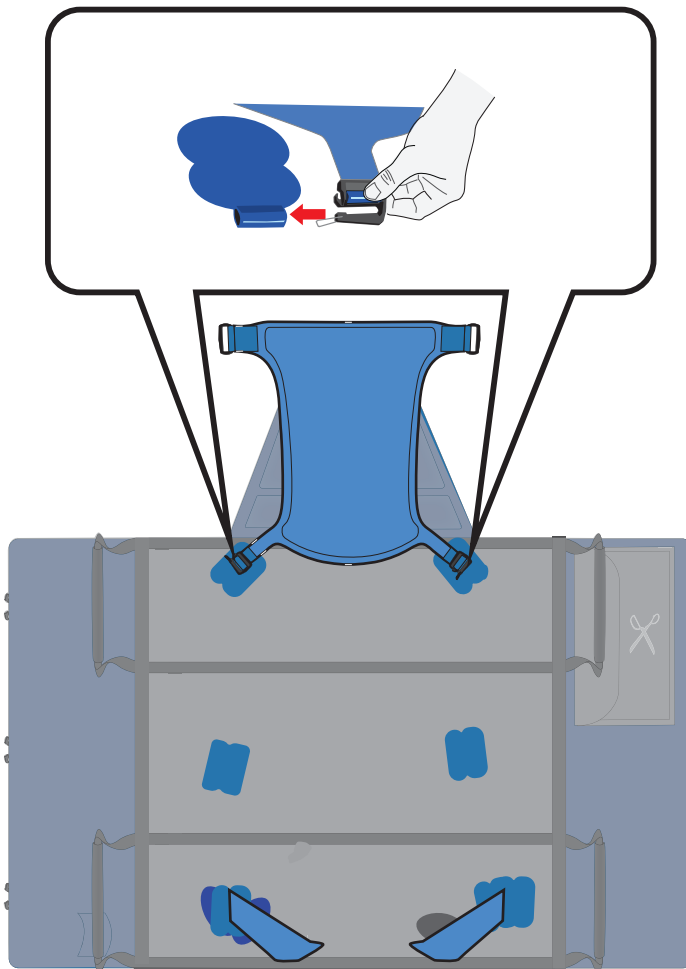

Figure 8.2. Quick Case carry sheet outside and inside

Number	Description	Number	Description
1	Battery indicator window	8	Platform wrap
2	Battery protector cover	9	Waist strap loops (2)
3	Carrying handles (4)	10	Waist strap (2)
4	Backpack straps	11	Platform holding straps (2)
5	Handle to position the platform	12	Handles (8)
6	Sheet for carrying the patient	13	Second fold mark (top blue line)
7	Scissors pocket	14	First fold mark (bottom blue line)
		15	Final fold mark (yellow)

Attaching the platform to the Quick Case carry sheet

1. Fully open the Quick Case carry sheet and attach the top part of the platform wrap.



2. Place the platform into the platform holding straps. Make sure that the platform fits tightly.

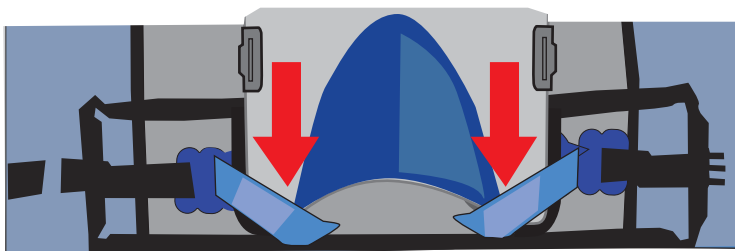

3. Secure the platform to the Quick Case carry sheet using the bottom 2 straps on the platform wrap.

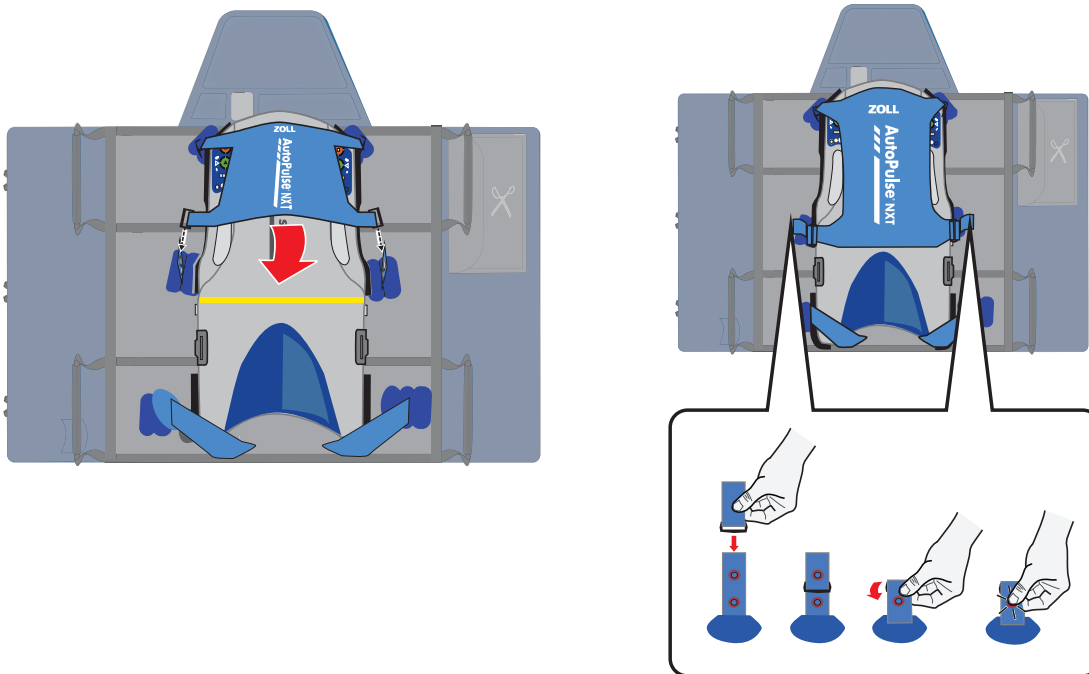

4. Place the band on the platform. Place the waist straps (10) into the left and right waist strap loops (9).

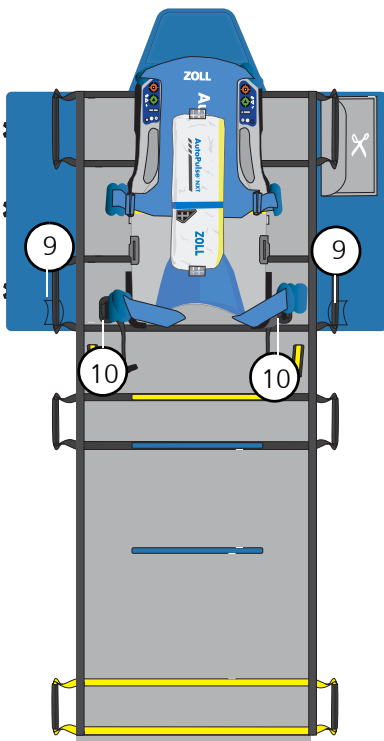

Folding the Quick Case carry sheet

1. Pull the gray part of the Quick Case carry sheet from the bottom to the top.

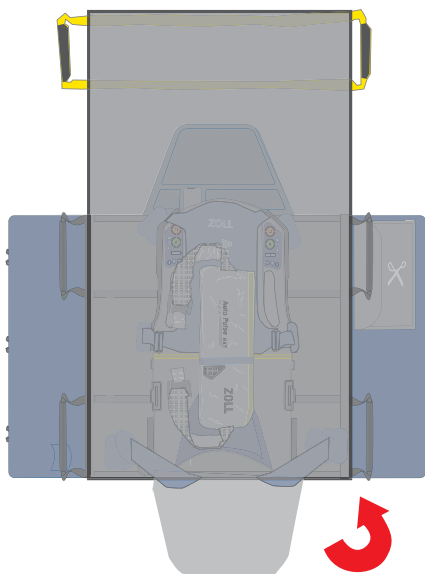

2. Fold the gray part of the Quick Case carry sheet in half, from the top to the bottom at the first fold mark (blue line).

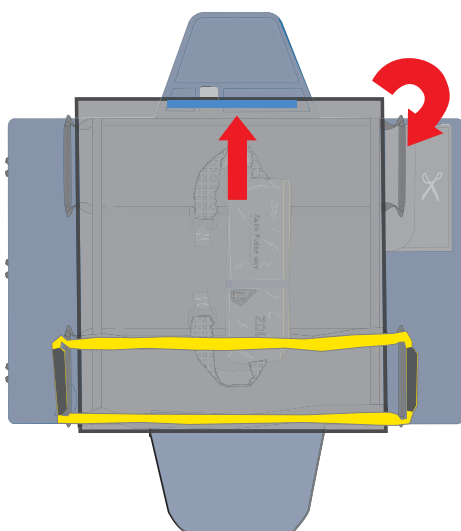

3. Fold the gray part of the Quick Case carry sheet in half again, from the top to the bottom at the second fold mark (blue line).

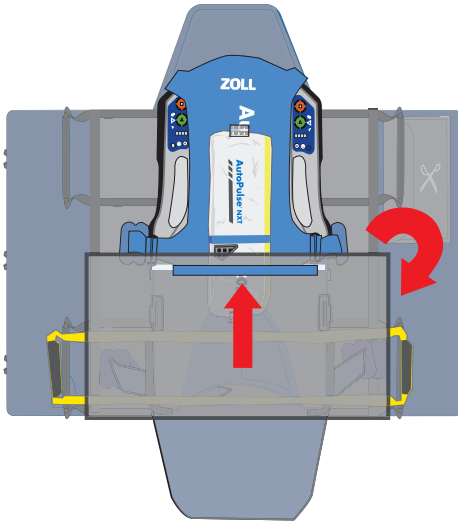

4. Fold the gray part of the Quick Case carry sheet in half again, from the top to the bottom, at the final fold mark (yellow line).

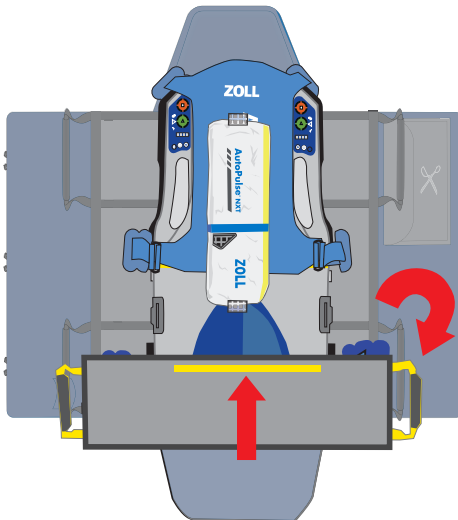

5. Fold the left side inwards.

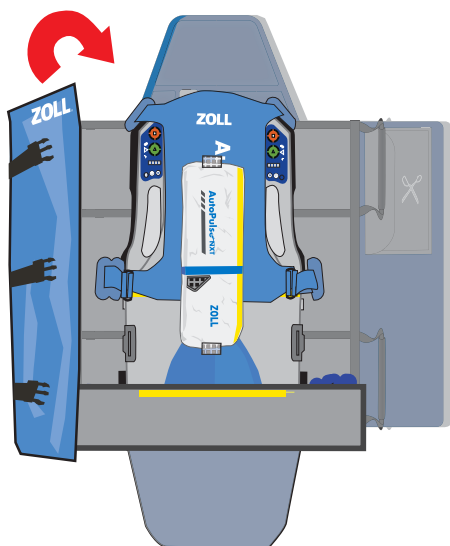

6. Fold the right side inwards. Secure the three black straps by connecting the buckles and tightening the straps.



Hygiene Barrier

The hygiene barrier is a plastic platform cover to reduce contamination during use and decrease the need for cleaning.

WARNING. Do not use a damaged hygiene barrier.

WARNING. For single use only.

1. Slip the hygiene barrier over the platform from the bottom to the top of the platform.

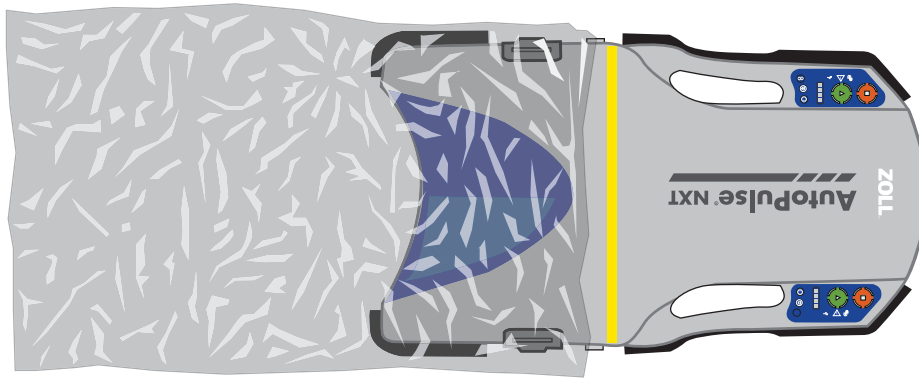

2. Make sure the openings in the hygiene barrier face the top of the platform, allowing access to the guard ports.

WARNING. Align the hygiene barrier openings with the battery, air vents and band attachment points.

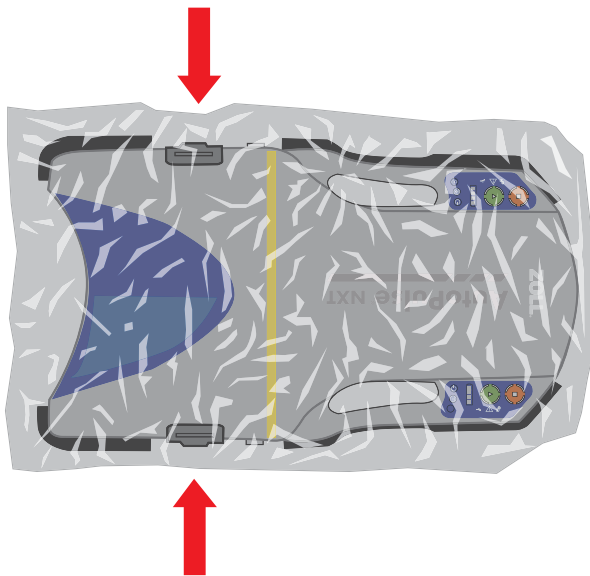

3. Install a new band. See “Installing the band” on page 16.

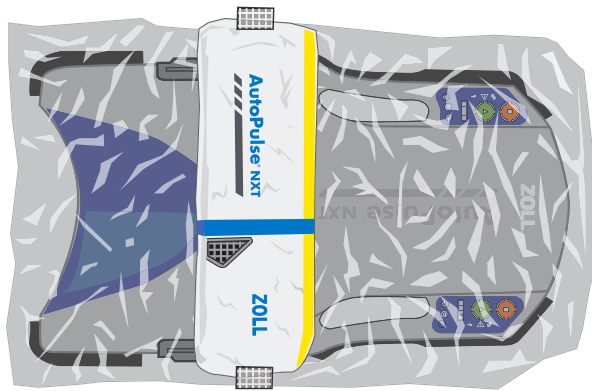

Shoulder Restraint

The shoulder restraint attaches to the platform to help maintain patient alignment with the platform during treatment.

1. Secure the black straps to the metal attachment points near the patient's head and the yellow straps to the quick release sockets located at the yellow line at the armpits.

Caution. Do not place the strap over the patient's neck or over the band.

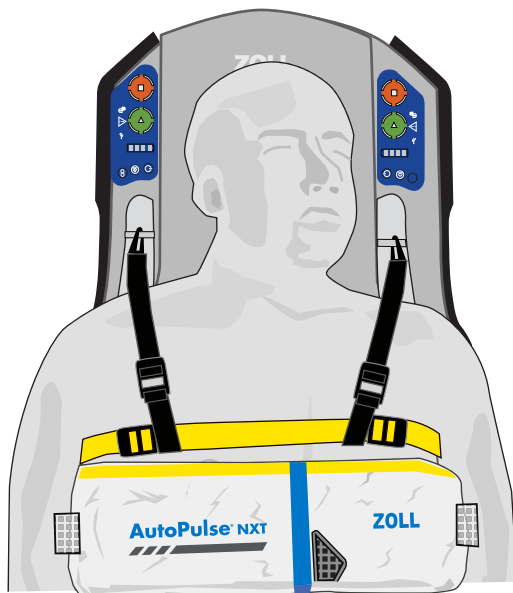

- Secure the black straps to the metal attachment points near the patient's head.

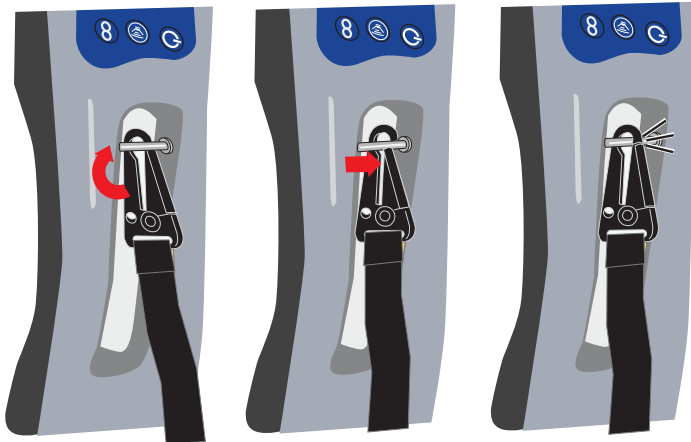

- Secure the yellow straps to the quick release sockets located at the yellow line at the armpits.

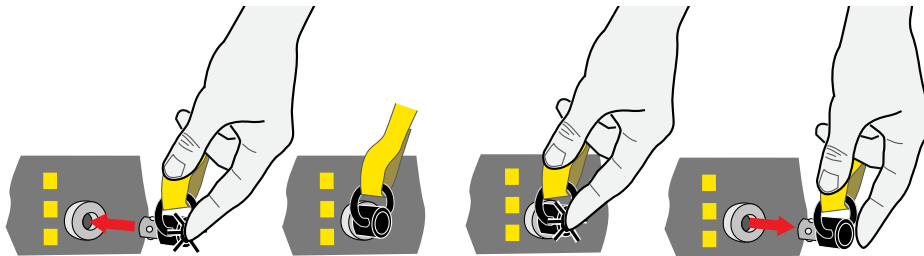

- Secure the patient by adjusting the yellow straps first, then the black straps. The center strap should be positioned so that it is between the band and the patient's sternal notch.
- Check to make sure the straps do not interfere with the movement of the band. Monitor the patient's alignment, and readjust as needed.

Warnings

- Inspect the shoulder restraint before each use. Discard if you observe:
 - Broken stitching
 - Frayed or cut fabric or straps
 - Broken, cracked, or deteriorated buckles, rings, closure or other types of connectors
 - Other signs of deterioration
- Check the patient frequently.
- Make sure the straps are not twisted.
- Make sure the straps are not entangled with the band.
- Monitor the patient for full chest recoil after tightening the straps.
- Improper use could result in serious injury.
- Motion can cause the patient to shift and shoulder restraints to loosen. Before starting or restarting treatment, ensure that you have correctly attached the shoulder restraint and the patient is aligned properly to the platform. During active compressions, regularly check to maintain correct patient alignment to the platform and band.

This page intentionally left blank.

9. Maintenance and Transport

This chapter provides information on:

- "System inspection" (page 53)
- "System cleaning" (page 53)
- "Transport, shipping and storage" (page 55)
- "Disposal" (page 55)

To ensure continued safe and reliable operation of the platform, battery, and charger, preventive maintenance and a comprehensive technical inspection is required periodically. Service and preventive maintenance should be performed every two years or upon reaching 60 hours of runtime, whichever occurs first. Contact your sales or service representative for information on preventive maintenance pricing and complete service packages available in your area.

System inspection

The system should be ready for deployment at all times. The platform conducts a self-test each time it is turned on. In addition, include system checks in your Emergency Medical Service (EMS) rig check or hospital procedures. See Appendix A, "System Checklist," on page 59.

The system has no user-serviceable parts. Periodically inspect the system. All repairs or service must be performed by qualified service personnel. Contact a ZOLL representative for assistance.

Inspecting the platform

To inspect the platform:

1. Inspect the platform for physical damage, including cracks, tears, and missing or broken pieces.
2. Remove the battery from the platform.
3. Check the battery compartment. Remove any debris.
4. Check the vent on each side.
5. Check the guard ports on each side.

Inspecting the battery

Inspect the battery, including the connector, for physical damage. If the battery is damaged, do not attempt to place it into the platform or battery charger. This can cause damage to the internal connector of the platform or battery charger.

Caution. Do not use a cracked battery. Do not strike or throw the battery. Do not use the battery to strike another object. Mishandling the battery may lead to physical damage and present a fire or shock hazard that could result in a burn or other related injury.

Inspecting the battery charger

To inspect the battery charger:

1. Inspect the battery charger for physical damage.
2. Check the battery compartment and vents on the bottom and back. Remove any debris.

System cleaning

Caution. Do not spray with or submerge the system in liquid.

Caution. Do not autoclave the platform, battery, or battery charger.

Caution. Do not clean the system during use.

Note. The USB and battery ports are sealed against moisture intrusion.

Cleaning system surfaces

To clean the surfaces of the system, wipe with one of the following products:

- 70% Isopropyl alcohol
- Chlorine bleach solution (up to 5000 ppm)

Cleaning the platform

1. Remove and dispose of the band.
2. Remove any debris from the vents on each side of the platform.
Caution. Do not spray any liquid into the vents.
3. Blow any debris from the band guard ports using compressed air. Do not insert tools or other objects.
4. Clean the platform's surfaces. See "Cleaning system surfaces" on page 54.
5. Make sure the platform is dry before storing.

Cleaning the battery

1. Clean the battery's surfaces. See "Cleaning system surfaces" on page 54.
Caution. Clean the battery connector with only a clean dry cloth and/or a non-conductive brush.
2. Make sure the battery is completely dry before placement in the platform or battery charger.

Cleaning the battery charger

1. Unplug the battery charger.
2. Remove any lint, dust, or other debris from the vents on the bottom and back. Use a vacuum if necessary. Do not use compressed air, as it may blow the dust or lint into the unit and damage the internal fans.
3. Clean the battery charger's surfaces. See "Cleaning system surfaces" on page 54.
4. Make sure it is dry.

Cleaning the Quick Case carry sheet

The Quick Case carry sheet can be washed with detergent by hand, or in an industrial washing machine (to avoid mechanical wear) at a maximum of 86°F (30°C). Use mild liquid detergent, as dry powder can leave detergent residue on the fabric. For machine washing, an additional rinse cycle with clear water is recommended.

Note. Never use the spin cycle as this may cause damage to the waterproof coating.

Dry the Quick Case carry sheet at room temperature.

Never put in a tumble dryer, dry in direct sunlight or near radiators.

Cleaning the shoulder restraint

The shoulder restraint can be washed with detergent by hand or in a washing machine. Use mild liquid detergent as dry powder can leave detergent residue on the fabric.

Transport, shipping and storage

Transport

Transport the platform in the Quick Case carry sheet. See "Platform Environmental Specifications" on page 65 for storage and transport temperatures.

Shipping

Keep the original shipping box and materials in case you need to ship the system or return it for service. See "Device Return, Packing, and Shipping Instructions" on page 58.

Storage

Store the system in a cool, dry place. Storage in a wet or humid environment may result in damage that may require service.

WARNING. Do not leave battery in direct sunlight for extended periods.

WARNING. Do not crush the battery.

Caution. Battery capacity degrades if stored above 35°C (95°F) for an extended period of time.

To store the system:

1. Turn off the platform.
2. For platforms in active use, store the fully charged battery in the platform for up to one week. See "Battery description" on page 21.
3. Store the spare battery in the battery charger.
4. Store the system in a cool dry place.

Disposal

Remove the battery from the platform and battery charger. Dispose in accordance with local governing ordinances and recycling plans for lithium-ion batteries.

WARNING. Heating, burning, or incinerating a battery may result in fire or explosion.

Dispose of the platform or battery charger in accordance with local governing ordinances and recycling plans for electronic waste.

The band is for single use only. Once used, dispose of the band as biohazard waste.

This page intentionally left blank.

10. Warranty & Technical Support

ZOLL Factory Limited Warranty for AutoPulse NXT System

ZOLL Medical Corporation (ZOLL) warrants to the initial Purchaser (Customer) that from the date of shipment from ZOLL's facility, the Equipment (constituting the AutoPulse NXT[®] Resuscitation System platform, AutoPulse NXT battery charger, and AutoPulse NXT battery) shall be free from defects in material and workmanship, for a period of one (1) year ("Warranty Period") after the initial purchase date or the date the platform is first placed in service, whichever date occurs later, not to exceed two (2) years from the date of manufacturing, when properly operated, maintained, and used for its intended purpose. Excluded from this warranty are single use, disposable components such as the NXT Band. The Factory Warranty covers all parts, labor, shipping and insurance costs for the repair of the equipment. A service loaner may be provided at no charge for use during the repair upon request.

ZOLL reserves the right to make any necessary repair at ZOLL's manufacturing facility or at any ZOLL-authorized repair center. Repair or replacement of equipment under this warranty does not extend the Warranty Period.

This warranty does not include preventative or scheduled maintenance. This warranty shall be void if any labels or other identifying marks permanently affixed to the equipment when shipped by ZOLL are removed, altered, defaced or obliterated. All equipment or parts replaced shall become property of ZOLL.

The Band shall be warranted for 90 days from date of factory shipment. During such period, ZOLL will, at its sole discretion, either repair or replace at no charge to the Customer the band or accessories found by ZOLL to be defective in material or workmanship. If ZOLL's inspection detects no defects in material or workmanship, ZOLL's regular service charges shall apply.

Exclusions

ZOLL shall not be responsible for any equipment defect, the failure of the equipment to perform any specified function, or any other non-conformance of the equipment caused by or attributable to: any modification of the equipment by the Customer, unless such modification is made with the prior written approval of ZOLL, the use of the equipment with any associated or complementary equipment, accessory or software not supplied by ZOLL; any misuse or abuse of the equipment; exposure of the equipment to conditions beyond the environmental, power or operating constraints specified by ZOLL; the serial number being removed or made illegible; modifications made by anyone other than ZOLL or its expressly authorized representative; use of the equipment other than in accordance with ZOLL's instructions.

ZOLL shall have no obligation to make repairs, replacements, or corrections which result, in whole or in part, from normal wear and burnout during use, including but not limited to bearings, fuses, cables and LEDs. The foregoing warranty does not apply to software included as part of the equipment (including software embodied in read-only memory, known as "firmware").

THE WARRANTY SET FORTH HEREIN IS EXCLUSIVE AND ZOLL EXPRESSLY DISCLAIMS ALL OTHER WARRANTIES WHETHER WRITTEN, ORAL, IMPLIED, OR STATUTORY, INCLUDING BUT NOT LIMITED TO ANY WARRANTIES OR MERCHANTABILITY OR FITNESS FOR A PARTICULAR PURPOSE.

ZOLL's maximum liability arising out of the sale of the equipment, disposables, and accessories or their use, whether based upon warranty, contract, tort or otherwise, shall not exceed the actual payments received by ZOLL in connection therewith. ZOLL shall not be liable for any incidental, special or consequential loss, damage or expense (including without limitation lost profits) directly or indirectly arising from the sale, inability to sell, use or loss of use of any equipment (however caused and on any theory of liability), even if ZOLL has been advised of the possibility of such loss. The foregoing limitations shall not apply to any claims for bodily injury or death to the extent that limitation of damages for such claims are unenforceable or against public policy under any applicable statute or rule of law.

Technical Support

ZOLL provides factory-based technical support for the AutoPulse NXT system and accessories. ZOLL Technical Support can answer questions, provide guidance, and schedule service for your system.

In the U.S., contact ZOLL Technical Support at 1-800-348-9011. Outside the U.S., contact your local ZOLL representative.

Device Return, Packing, and Shipping Instructions

Call ZOLL Technical Support to obtain a Return Material Authorization (RMA) or Customer Call Report (CCR) number before returning any AutoPulse NXT platform, battery charger, battery, band, or accessory to ZOLL. ZOLL Technical Support will provide instructions to prepare the item for return shipment, and can provide a shipping box if required. The RMA or CCR number must be clearly marked on the outside of the shipping box and included in the accompanying shipment documentation. Carefully pack items to avoid damage during shipment. Any items used clinically must be placed into appropriate biohazard bags before being returned to ZOLL.

This page intentionally left blank.

Appendix B. Troubleshooting

This appendix provides information on:

- "Troubleshooting the platform" on page 61
- "Troubleshooting the band" on page 61
- "Troubleshooting the battery" on page 63
- "Troubleshooting the battery charger" on page 64

Troubleshooting the platform

Solid alert indicator

If the alert indicator is solid and the platform does not compress:

1. Check that the user control panel buttons are not accidentally pressed.
2. Check the battery charge status (Table 5.1 on page 25) on the User control panel (page 10). Replace the battery if needed.
3. If no battery replacement is needed, turn the platform off and on.
4. If you are still unable to use the platform, immediately revert to manual CPR.
5. Ensure that the long and short sides of the band are correctly attached to each other. The platform may fail to find the patient if the band opens during patient sizing.
6. Check for anything blocking the platform vents, which may cause overheating. Remove any blockage. Do not turn off the platform. The platform internal fans cool the system after about two minutes.
7. Bring the system temperature within operating range, See "Operating the system" on page 34.
8. Turn off the platform.
9. Turn on the platform.
10. If the issue persists, continue manual CPR.

Flashing alert indicator

If the alert indicator is flashing, the system has failed. Begin manual CPR immediately. Contact "Technical Support" (page 58). See Table 3.1, "User control panel," on page 10.

Troubleshooting the band

Cut bands

If the band has been cut:

1. Turn off the platform.
2. Make sure the band guards are in place.
3. Turn on the platform.
4. Remove the band guards from the platform. See "Removing the band" on page 19.

Retracting bands

The band is installed. If the band immediately retracts when turning on the platform but without pressing Start, do the following:

1. Turn off the platform.
2. Pull the band up to unwind the bands from the platform.
3. Remove the band guards and pins from the guard port. See “Removing the band” on page 19.
4. Install the band guards but not pins on the guard port. See “Installing the band” on page 16.
5. Turn on the platform.
The platform spools should return to the correct position. See Figure 4.2, “Platform spool,” on page 17.
6. Remove the band guards.
7. Reinsert the band pins into the guard ports.
8. Reinstall the band guards.
9. Turn off the platform.
10. Turn on the platform.
The band should remain loose until the Start button is pressed.

Unable to reach the spool retention slots in the guard ports

If the spool in the guard port cannot be reached to install the band, do the following:

1. Install the band guards, but not the pins, in the guard port. See “Installing the band” on page 16.
2. Turn on the platform.
The platform spools should return to the correct position. See Figure 4.2, “Platform spool,” on page 17.
3. Remove the band guards.
4. Insert the guard’s pins into the guard ports.
5. Reinstall the band guards.

Band not completely unwound from platform

To manually remove the band from the platform, pull the band until the band is unwound and the pin is visible and able to be removed.

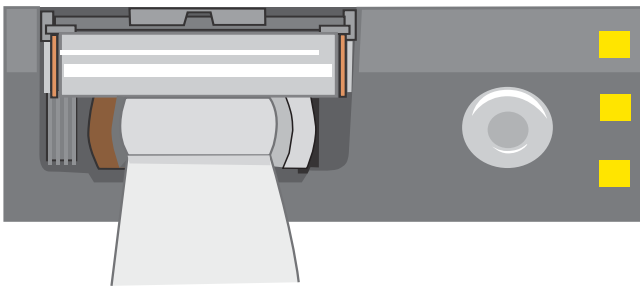

Figure B.1. Belt of the band wrapped around platform spool

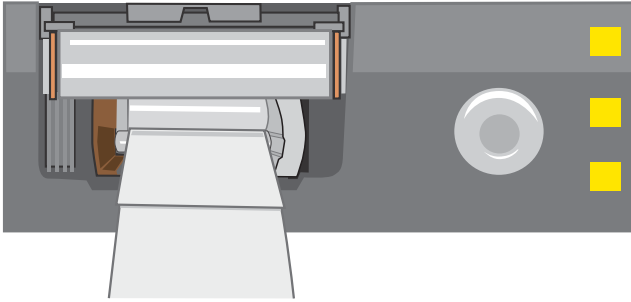

Figure B.2. Unwound belt of the band

Troubleshooting the battery

Symptom	Possible Cause	Recommended Action
The battery charge status indicator does not illuminate.	The battery's status is unknown.	Put the battery into the battery charger. 1. If the battery charge status indicator is slowly flashing, the battery charger is attempting to restore the battery. See "Using the battery charger" on page 27. 2. If the alert indicator is illuminated, the battery has failed. Replace the battery. See "Disposal" on page 55.
The battery does not fully insert into the battery charger or platform.	The battery may be damaged.	Inspect the guide rails and battery connector. If the guide rails or battery connector are damaged, replace the battery.
	The battery compartment may be obstructed.	Check the battery compartment for any debris.
The Battery charge status on the platform shows one bar flashing but the Alert indicator is not flashing.	The battery charge is low.	Prepare to replace the battery with a fully charged battery.
The Battery charge status on the platform shows one bar flashing and the Alert indicator is flashing.	The battery charge is depleted.	Replace the battery with a fully charged battery.

Table B.1: Battery troubleshooting (1 of 2)

Symptom	Possible Cause	Recommended Action
The battery charger's alert indicator is illuminated.	<p>One of the following has occurred. The battery has:</p> <ul style="list-style-type: none"> Failed to charge Failed the measurement cycle 	<p>Remove the battery from the battery charger. Press the battery's status check button:</p> <ul style="list-style-type: none"> If the battery alert indicator illuminates, the battery has failed. Replace the battery. See "Disposal" on page 55. If no indicators illuminate, the battery has failed. Replace the battery. See "Disposal" on page 55. If a battery's internal temperature is out of range (Table C.4 on page 66), it does not charge. Remove from the battery charger, allow the battery to return to its operating temperature range (may take up to 3 hours), and reinsert in the battery charger. If the battery's charge indicators illuminate, remove and reinsert the battery. If the battery's alert indicator remains illuminated, contact "Technical Support" (page 58).

Table B.1: Battery troubleshooting (2 of 2)

Troubleshooting the battery charger

Symptom	Possible Cause	Recommended Action
The battery charger power indicator does not illuminate.	The battery charger power cord is not plugged in.	See "Setting up the battery charger" on page 27.
	The circuit breaker tripped.	See "Battery charger circuit breaker" on page 31.
Charging a battery takes much longer than 2 hours.	The battery charger temperature is out of range.	<p>Make sure the battery charger:</p> <ul style="list-style-type: none"> Temperature is within range (Table C.5 on page 67) Has adequate ventilation
The alert indicator is illuminated for a battery bay.	There might be a battery error.	<ol style="list-style-type: none"> Remove the battery from the battery charger. Insert the battery into the other battery bay. If the alert indicator illuminates for the other battery bay, do not use the battery. Contact "Technical Support" (page 58).

Table B.2: Battery charger troubleshooting

Appendix C. Technical Specifications

The specifications provided in this appendix apply to the AutoPulse NXT System.

System Operating Parameters

Category	Specifications
Chest displacement ¹	Equal to 20% reduction in anterior-posterior chest depth
Physiological duty cycle ¹	50 ± 5%
Compression rate ¹	80 ± 5 compressions per minute
Compression modes	<ul style="list-style-type: none"> • 30:2 (30 compressions with a three second ventilation pause) • Continuous compressions

Table C.1: Operating Parameters

1. Essential performance categories.

Platform Physical Specifications

Category	Specifications
Manufacturer	ZOLL Circulation, Inc.
Size (LxWxH)	73.7 cm x 43.2 cm x 7.6 cm (29 in. x 17 in. x 2.9 in.)
Weight (excluding AutoPulse Battery)	8.3 kg (18.3 lbs)

Table C.2: Platform Physical Specifications

Note. The patient surface of the platform and band comprise the applied parts as defined by IEC 60601-1, Edition 3.1, the parts of the system that normally have physical contact with the patient.

Note. This device complies with the EN 1789 drop height requirement.

Platform Environmental Specifications

Category	Specifications
Operating temperature	0°C (32°F) to 45°C (113°F) 10°C (50°F) to 40°C (104°F) (preferred)
Storage/Transport temperature	-20°C (-4°F) to 60°C (140°F)
Relative humidity	15% to 95%, non-condensing

Table C.3: Platform Environmental Specifications

Category	Specifications
Atmospheric pressure	683 mmHg to 428 mmHg (91 kPa to 57 kPa); 3000 ft to 15,000 ft (914 m to 4572 m) operating in 0°C to 40°C (32°F to 104°F) environment
	795 mmHg to 683 mmHg (106 kPa to 91 kPa); -1000 ft to 3000 ft (-305 m to 914 m) operating in 0°C to 45°C (32°F to 113°F) environment
Ingress protection	Ingress protection as defined by IP44 per International Electrotechnical Commission IEC 60529
Safety classification	Meets IEC 60601-1 – internally powered equipment, Type BF-Defibrillation Proof, portable, continuous operation
Electromagnetic immunity	IEC 61000-4-3, 4, 5, and 6 – level 2 (80 MHz to 2 GHz, 10V/m)
Electrostatic discharge	Meets IEC 61000-4-2 – 18 KV Contact, +15 KV Air
Electromagnetic emissions	Meets CISPR 11/EN55011, Group 1, Class B
Patient contacting materials	Meets ISO 10993-1 Biological evaluation of medical devices
Shock	Meets IEC 60068-2-27 Basic Environmental Testing – Shock (50 g, 11 ms pulse, half sine wave)
Vibration	Meets IEC 60068-2-64 Basic Environmental Testing, Broad-band Random Vibration Test Fh, +20 Hz to +2000 Hz, +0.05 g ² /Hz Meets IEC 60068-2-6 Environmental Testing, Sinusoidal Vibration Test Fc, +10 Hz to +500 Hz, +50 m/s ²
Drop	IEC 60068-2-31 Basic Environmental Testing, Procedure 1. Tested at 0.5 m. EN 1789 Medical Vehicles and their equipment. Tested at 0.75 m.
Corrosion resistance	External components are non-corrosive
Operating classification	Short-time per IEC 60601-1 (30 minutes)

Table C.3: Platform Environmental Specifications (Continued)

Battery Physical and Environmental Specifications

Category	Specifications
Manufacturer	ZOLL Circulation, Inc.
Model Number	8700-001012-01
Size (LxWxH)	143 mm x 215 mm x 62 mm (5.6 in. x 8.5 in. x 2.4 in.)
Weight	1.67 kg (3.68 lb)
Type	Rechargeable Lithium-Ion (LiFePO ₄)
Battery voltage (nominal)	39.6 V DC
Capacity	2600 mAh (typical)
Current (maximum)	20 A continuous, 60 A peak
Initial battery capacity (nominal patient)	30 minutes (Typical expected runtime with a nominal patient using a new battery)
Maximum battery charge time	Less than 2 hours
Measurement cycle time	5 to 10 hours

Table C.4: Battery Physical and Environmental Specifications

Category	Specifications
Recommended replacement interval	5 years from date of manufacture
Operating temperature	0°C (32°F) to 45°C (113°F) ambient temperature when installed in device
Charge temperature	0°C (32°F) to 45°C (113°F) 10°C (50°F) to 30°C (86°F) (preferred)
Storage/Transport ambient temperature	-20°C (-4°F) to 60°C (140°F) for up to one week Do not store the battery for more than one month at temperatures above 35°C. Prolonged exposure to high storage temperatures results in reduced battery life.
Atmospheric pressure	795 mmHg to 428 mmHg (106 kPa to 57 kPa); -1000 ft to 15,000 ft (-305 m to 4572 m)
Enclosure protection	Meets IP44 per IEC 60529
Shock	Meets IEC 60068-2-27 Basic Environmental Testing Procedures – Shock (50 g, 11 ms pulse, half sine wave)
Vibration	Meets IEC 60068-2-6 Basic Environmental Testing Procedures (10 to 150 Hz, 10 m/s ²) Meets IEC 60068-2-64 Basic Environmental Testing Procedures – Random Vibration Broad Band – General Requirements (f1:20, f2:2000, ASD 0.05)
Free fall	Meets IEC 60068-2-31 Basic Environmental Testing Procedures – Free Fall – Procedure 1.
Electrostatic discharge	Meets IEC 61000-4-2, Level 4
Radiated emissions	Meets CISPR 11/EN55011, Group 1, Class B FCC part 15, Class A
Radiated Immunity	Meets IEC-61000-4-3, 80-2500 MHz, Level 3
Safety	Meets IEC-60601-1 including UL310DV.1.1 for Lithium batteries

Table C.4: Battery Physical and Environmental Specifications (Continued)

Battery Charger Physical And Environmental

Category	Specifications
Manufacturer	ZOLL Circulation, Inc.
Size (LxWxH)	29.1 cm x 28.4 cm x 18.2 cm (11.5 in. x 11.2 in. x 7.2 in.)
Weight	3.67 kg (8.1 lb)
Operating input voltage	100 to 240 V AC
Operating input frequency	50/60 Hz
Input current	5.0 Amps (maximum)
Maximum Battery charge time	Less than 2 hours at 25°C (77°F)
Circuit breaker	5A
Operating temperature	0°C (32°F) to 40°C (104°F)
Storage temperature	-20°C (-4°F) to 60°C (140°F)

Table C.5: Battery Charger Physical and Environmental Specifications

Category	Specifications
Relative humidity	15% to 95%, non-condensing.
Atmospheric pressure	795 mmHg to 428 mmHg (106 kPa to 57 kPa); -1000 ft to 15,000 ft (-305 m to 4572 m)
Enclosure protection	Meets IP22 per IEC 60529
Electrostatic discharge	Meets IEC 61000-4-2, – 18 KV Contact, +15 KV Air
RF electromagnetic fields immunity	Meets IEC 61000-4-3, Level 3
EFT/burst	Meets IEC 61000-4-4, Level 3
Surge immunity	Meets IEC 61000-4-5, Level 3
Conducted RF disturbances immunity	Meets IEC 61000-4-6, Class B
Dips, interruptions, and variations	Meets IEC 61000-4-11
Harmonics current emissions	Meets IEC 61000-3-2, Class B
Radiated emissions	Meets CISPR 11/EN55011, Group 1, Class B FCC part 15, Class A
Safety	Meets IEC/EN60601-1

Table C.5: Battery Charger Physical and Environmental Specifications (Continued)

Note. These requirements provide reasonable protection against harmful electromagnetic interference in a typical medical installation. However, high level of radio-frequency emissions from electrical devices, such as cellular phones, may disrupt the performance of this device. To mitigate disruptive electromagnetic interference, position this device away from radio frequency transmitters and other sources of electromagnetic energy.

Note. The battery charger is Class I type equipment with protective earthing/grounding.

Guidance and Manufacturer’s Declaration–Electromagnetic Emissions

Emissions test	Compliance	Electromagnetic environment - guidance
RF Emissions CISPR 11	Group 1	The platform and battery charger use RF energy for their internal function only. Therefore, its RF emissions are very low and are not likely to cause any interference in nearby equipment.
RF Emissions CISPR 11	Class B	The platform and battery charger are suitable for use in all establishments other than domestic and those directly connected to a low voltage power supply network which supplies buildings used for domestic purposes, provided the following warning is heeded. WARNING. This equipment is intended for use by healthcare professionals only. This equipment may cause radio interference or may disrupt the operation of nearby equipment. It may be necessary to take mitigation measures, such as re-orienting or relocating the battery charger or shielding the location.
Harmonic Emissions IEC 61000-3-2	Not applicable	
Voltage Fluctuations / Flicker Emissions IEC 61000-3-3	Not applicable	

Table C.6: Guidance and Manufacturer’s Declaration–Electromagnetic Emissions

Medical Electrical Equipment needs special precautions regarding EMC and needs to be installed and put into service according to EMC information provided in this document.

Table C.6: Guidance and Manufacturer’s Declaration–Electromagnetic Emissions

Electromagnetic Immunity Declaration (EID)

The battery charger is intended for use in the electromagnetic environment specified below.

Immunity test	IEC 60601 Test Level	Compliance Level	Electromagnetic environment–guidance
Electrostatic Discharge (ESD) IEC 61000-4-2	± 8 kV contact ±15 kV air	± 8 kV contact ± 15 kV air	Floors should be wood, concrete, or ceramic tile. If floors are covered with synthetic material, the relative humidity should be at least 30%.
Electrical fast transient/burst IEC 61000-4-4	±2 kV AC Mains ±1 kV I/O lines 5/50 100 kHz	±2 kV AC Mains ±1 kV I/O lines 5/50 100 kHz	Mains power should be that of a typical commercial or hospital environment.
Surge IEC 61000-4-5	±1 kV Line to Line ± 2 kV Line to Earth	±1 kV Line to Line ± 2 kV Line to Earth	Mains power should be that of a typical commercial or hospital environment.
Voltage dips, short interruptions, and voltage variations on power supply input lines IEC 61000-4-11	>0% U_T , for 0.5 cycle ¹ At 0°, 45°, 90°, 135°, 180°, 225°, 270°, and 315°	>0% U_T , for 0.5 cycle ¹ At 0°, 45°, 90°, 135°, 180°, 225°, 270°, and 315°	Mains power should be that of a typical commercial or hospital environment. If user requires continued operation during power mains interruption, it is recommended the battery charger be powered from an uninterruptible power supply.
	0% U_T , 1 cycle and 70% U_T , 25/30 cycles Single phase at 0°	0% U_T , 1 cycle and 70% U_T , 25/30 cycles Single phase at 0°	
Voltage interruptions	0% U_T , 250/300 cycles	0% U_T , 250/300 cycles	
Power frequency (50/60 Hz) magnetic field. IEC 61000-4-8	30 A/m	30 A/m	Power frequency magnetic fields should be at levels characteristic of typical location in a typical commercial or hospital environment.
Note. U_T is the a.c mains voltage prior to application of the test level.			

Table C.7: Guidance and Manufacturer’s declaration –Electromagnetic immunity for the battery charger

1. Applicable only to ME equipment and ME systems connected to a single-phase AC mains.

The platform’s essential performance is compression rate, physiological duty cycle, and compression depth as specified in Table C.1. The platform meets basic safety and essential performance when operated in the electromagnetic environment specified in the following tables.

The platform is intended for use in the electromagnetic environment specified below.

Immunity test	IEC 60601 Test Level	Compliance Level	Electromagnetic environment–guidance
Electrostatic Discharge (ESD) IEC 61000-4-2	± 8 kV contact ±15 kV air	± 8 kV contact ± 15 kV air	Floors should be wood, concrete, or ceramic tile. If floors are covered with synthetic material, the relative humidity should be at least 30%.
Power frequency (50/60 Hz) magnetic field. IEC 61000-4-8	30 A/m	30 A/m	Power frequency magnetic fields should be at levels characteristic of typical location in a typical commercial or hospital environment.

Table C.8: Guidance and Manufacturer’s declaration –Electromagnetic immunity for the platform

The battery charger is intended for use in the electromagnetic environment specified below.			
Immunity test	IEC 60601 Test Level	Compliance Level	Electromagnetic environment guidance
Conducted RF IEC 61000-4-6	3 Vrms 1 kHz 0.15 – 80 MHz	3 Vrms 1 kHz 0.15 – 80 MHz	<p>Portable and mobile RF communications equipment should be used no closer to any part of the battery charger, including cables, than the recommended separation distance calculated from the equation applicable to the frequency of the transmitter.</p> <p>Recommended separation distance</p> $d = 1.17 \sqrt{P} \text{ 0.15 to 80 MHz}$ $d = 1.17 \sqrt{P} \text{ 80 to 800 MHz}$ $d = 2.3 \sqrt{P} \text{ 800 MHz to 2.7 GHz}$ <p>Where P is the maximum output power rating of the transmitter in watts (W) according to the transmitter manufacturer and d is the recommended separation distance in meters (m).</p> <p>Field strengths from fixed RF transmitters, as determined by an electromagnetic site survey,¹ should be less than the compliance level in each frequency range.²</p> <p>Interference may occur in the vicinity of equipment marked with the following symbol:</p> 
Radiated RF IEC 61000-4-3	<p>3 V/m 80 MHz to 2.7 GHz 6 V/m in ISM bands³</p> <p>Spot frequencies 385 MHz – 5.750 GHz Pulse Modulation</p>	<p>3 V/m 80 MHz to 2.7 GHz 6 V/m in ISM bands³</p> <p>Spot frequencies 385 MHz – 5.750 GHz Pulse Modulation</p>	
<p>Note 1: At 80 MHz and 800 MHz, the higher frequency range applies.</p> <p>Note 2: These guidelines may not apply in all situations. Electromagnetic propagation is affected by absorption and reflection from structures, objects, and people.</p>			

Table C.9: Guidance and manufacturer's declaration – electromagnetic immunity for the battery charger

1. Field strengths from fixed transmitters, such as base stations for radio (cellular/cordless) telephones and land mobile radios, amateur radio, AM and FM radio broadcast and TV broadcast cannot be predicted theoretically with accuracy. To assess the electromagnetic environment due to fixed RF transmitters, an electromagnetic site survey should be considered. If the measured field strength in the location in which the battery charger is used exceeds the applicable RF compliance level above, the battery charger should be observed to verify normal operation. If abnormal performance is observed, additional measures may be necessary, such as re-orienting or relocating the battery charger.
2. Over the frequency range 150 kHz to 80 MHz, field strengths should be less than 3 V/m.

Appendix C. Technical Specifications

3. The ISM (industrial, scientific, and medical) bands between 0.15 MHz and 80 MHz are 6.765 MHz to 6.795 MHz; 13.553 MHz to 13.567 MHz; 26.957 MHz to 27.283 MHz; and 40.66 MHz to 40.70 MHz. The amateur radio bands between 0.15 MHz and 80 MHz are 1.8 MHz to 2.0 MHz, 3.5 MHz to 4.0 MHz, 5.3 MHz to 5.4 MHz, 7 MHz to 7.3 MHz, 10.1 MHz to 10.15 MHz, 14 MHz to 14.2 MHz, 18.07 MHz to 18.17 MHz, 21.0 MHz to 21.4 MHz, 24.89 MHz to 24.99 MHz, 28.0 MHz to 29.7 MHz, and 50.0 MHz to 54.0 MHz.

The platform is intended for use in the electromagnetic environment specified below.			
Immunity test	IEC 60601 Test Level	Compliance Level	Electromagnetic environment guidance
RF IEC 61000-4-3	10 V/m 80 MHz to 2.7 GHz Spot frequencies 385 MHz – 5.750 GHz Pulse Modulation	20 V/m 80 MHz to 2.7 GHz Spot frequencies 385 MHz – 5.750 GHz Pulse Modulation	<p>Portable and mobile RF communications equipment should be used no closer to any part of the battery charger, including cables, than the recommended separation distance calculated from the equation applicable to the frequency of the transmitter.</p> <p>Recommended separation distance</p> $d = 1.17 \sqrt{P} \text{ 0.15 to 80 MHz}$ $d = 1.17 \sqrt{P} \text{ 80 to 800 MHz}$ $d = 2.3 \sqrt{P} \text{ 800 MHz to 2.7 GHz}$ <p>Where P is the maximum output power rating of the transmitter in watts (W) according to the transmitter manufacturer and d is the recommended separation distance in meters (m).</p> <p>Field strengths from fixed RF transmitters, as determined by an electromagnetic site survey,¹ should be less than the compliance level in each frequency range.²</p> <p>Interference may occur in the vicinity of equipment marked with the following symbol:</p> 
<p>Note 1: At 80 MHz and 800 MHz, the higher frequency range applies.</p> <p>Note 2: These guidelines may not apply in all situations. Electromagnetic propagation is affected by absorption and reflection from structures, objects, and people.</p>			

Table C.10: Guidance and manufacturer's declaration – electromagnetic immunity for the platform

1. Field strengths from fixed transmitters, such as base stations for radio (cellular/cordless) telephones and land mobile radios, amateur radio, AM and FM radio broadcast and TV broadcast cannot be predicted theoretically with accuracy. To assess the electromagnetic environment due to fixed RF transmitters, an electromagnetic site survey should be considered. If the measured field strength in the location in which the battery charger is used exceeds the applicable RF compliance level above, the battery charger should be observed to verify normal operation. If abnormal performance is observed, additional measures may be necessary, such as re-orienting or relocating the battery charger.
2. Over the frequency range 150 kHz to 80 MHz, field strengths should be less than 3 V/m.

Note. The following degradations associated with essential performance were not allowed during test: component failure, changes in programmable parameters, resets to factory defaults, changes in operating modes, or data corruption.

The battery charger and platform are intended for use in an electromagnetic environment in which radiated RF disturbances are controlled. The customer or the user of the battery charger or platform can help prevent electromagnetic interference by maintaining a minimum distance between portable and mobile RF communications equipment (transmitters) and the battery charger or platform as recommended below, according to the maximum output power of the communications equipment.			
Radiated maximum output power of transmitter W	Separation distance according to frequency of transmitter m		
	150 kHz to 80 MHz $d = 1.17 \sqrt{P}$	80 MHz to 800 MHz $d = 1.17 \sqrt{P}$	800 MHz to 2.5 GHz $d = 2.33 \sqrt{P}$
0.01	0.12	0.12	0.23
0.1	0.37	0.37	0.74
1	1.17	1.17	2.33
10	3.70	3.70	7.38
100	11.70	11.70	23.33
For transmitters rated at a maximum output power not listed above, the recommended separation distance d in meters can be determined using the equation applicable to the frequency of the transmitter, where P is the maximum output power rating of the transmitter in watts according to the transmitter manufacturer.			
Notes At 80 MHz and 800 MHz, the separation distance for the higher frequency range applies. These guidelines may not apply in all situations. Electromagnetic propagations affected by absorption and reflection from structures, objects, and people.			

Table C.11: Recommended separation distances between portable and mobile RF communications equipment and the battery charger or platform

Medical Electrical Equipment needs special precautions regarding EMC and needs to be installed and put into service according to the EMC information in this guide.

Portable and mobile RF communications equipment can affect Medical Electrical Equipment.

The use of accessories, transducers, and cables other than those specified by the manufacturer, may result in increased emissions or decreased Immunity of the battery charger.

The battery charger and platform should be observed to verify normal operation in the configuration in which it will be used.

WARNING. Portable RF communications equipment (including peripherals such as antenna cables and external antennas) should be used no closer than 30 cm (12 inches) to any part of the system, including cables specified by the manufacturer. Otherwise, degradation of the performance of this equipment could result.

WARNING. Battery charger only: To minimize risk of electric shock, when a potential equalization bus bar is available, connect to the potential equalization port on the back of the battery charger using the ZOLL grounding cable or equivalent.

Wireless Output Guidance and Manufacturer's Declaration

RF Transmission Emitted (IEC 60601-1-2)

This device complies with IEC 60601-1-2 for medical electrical equipment and medical electrical systems that include RF transmitters as specified below.

Standard	Frequency Range	Effective Radiated Power	Modulation Type	Data Rates
Bluetooth	2400-2483.5 MHz	10 mW	FHSS; GFSK/DQPSK/8DPSK	1, 3 Mbps

FCC Notice

ZOLL Medical Corporation has not approved any changes or modifications to this device by the user. Any changes or modifications could void the user's authority to operate the equipment. See 47 CFR Section 15.21.

This device complies with part 15 of the FCC Rules. Operation is subject to the following two conditions:

1. This device may not cause harmful interference.
2. This device must accept any interference received, including interference that may cause undesired operation. See 47 CFR Section 15.19(a)(3).

The user is cautioned to maintain 20 cm (8 inches) of space from the device to ensure compliance with FCC requirements.

This product is certified as type of the portable device with FCC Rules. To maintain compliance with RF Exposure requirement, please use within specification of this product.

The antenna used for this transmitter must not be co-located or operating in conjunction with any other antenna or transmitter.

The Bluetooth module can change the output power depending on the circumstances by the application software which is developed by module installer. An end user cannot change the output power.

Contains Transmitter Module FCC ID: RYYEYSHCN

Note. Harmful Interference is defined by the FCC as follows: Any emission, radiation or induction that endangers the functioning of a radio navigation service or of other safety services or seriously degrades, obstructs or repeatedly interrupts a radio communications service operating in accordance with FCC rules.

Canada, Industry Canada (IC) Notices

This device complies with Industry Canada license-exempt RSS standard(s).

Operation is subject to the following two conditions:

1. This device may not cause harmful interference.
2. This device must accept any interference received, including interference that may cause undesired operation. See 47 CFR Section 15.19(a)(3).

This product is certified as type of the portable device with Industry Canada Rules. To maintain compliance with RF Exposure requirement, please use within specification of this product.

IC: 4389B-EYSHCN

Contains Transmitter module IC: 4389B

Appendix D. Performance Report Alerts Table

The table below provides a list of codes that may be present on an AutoPulse NXT Performance Report. This information is provided to assist in the diagnosis and resolution on an Illuminated Alert indicator.



Code	Description	Action
1020	Motor fault	Contact Technical Support.
1040	Compression depth tolerance reached	Contact Technical Support.
1041	Compression depth tolerance reached	Contact Technical Support.
1050	Spool misaligned	Contact Technical Support.
1051	Spool misaligned	Contact Technical Support.
1060	Motor fault	Contact Technical Support.
1071	Motor fault	Contact Technical Support.
1072	Motor fault	Contact Technical Support.
1073	Motor fault	Contact Technical Support.
1091	Motor fault	Contact Technical Support.
1101	Motor fault	Contact Technical Support.
1102	Compression rate tolerance reached	Contact Technical Support.
1103	Compression rate tolerance reached	Contact Technical Support.
1120	Motor fault	Contact Technical Support.
1130	Motor fault	Contact Technical Support.
1160	Low battery	Replace with a fully charged battery.
1165	Battery fault	Replace battery. If the error persists, contact Technical Support.
1180	Motor fault	Contact Technical Support.
1181	Sensor fault	Contact Technical Support.
1185	Sensor fault	Contact Technical Support.
1190	Sensor fault	Contact Technical Support.
1200	Sensor fault	Contact Technical Support.
1210	Sensor fault	Contact Technical Support.
1225	Battery sensor fault	Contact Technical Support.
1230	Battery temperature sensor fault	Replace battery. If the error persists, contact Technical Support.
1240	Battery temperature sensor fault	Replace battery. If the error persists, contact Technical Support.
1260	Surface temperature sensor fault	Contact Technical Support.
1270	Surface temperature sensor fault	Place the platform in a cooler environment. If the error persists, contact Technical Support.

Appendix D. Performance Report Alerts Table

Code	Description	Action
1280	Motor temperature sensor fault	Contact Technical Support.
1290	Motor temperature sensor fault	Place the platform in a cooler environment. If the error persists, contact Technical Support.
1300	Fan fault	Contact Technical Support.
1330	User interface fault	Contact Technical Support.
1340	User interface fault	Contact Technical Support.
1401	Software error	Restart the platform. If the error persists, contact Technical Support.
1404	Software error	Restart the platform. If the error persists, contact Technical Support.
1407	Software error	Restart the platform. If the error persists, contact Technical Support.
60	Battery log error	No action needed.
80	Battery ID error	Contact Technical Support.
120	Motor alert	Place the platform in a cooler environment. If the error persists, contact Technical Support.
200	Left user interface fault	No action needed.
210	Right user interface fault	No action needed.
220	Left user interface fault	No action needed.
230	Right user interface fault	No action needed.
260	Left user interface fault	No action needed.
270	Right user interface fault	No action needed.

Quick Reference Guide

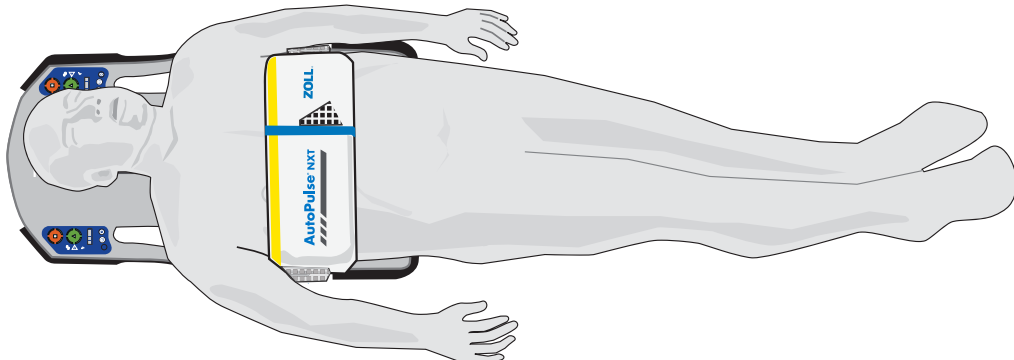
Note. Perform manual CPR until the patient is on the platform.

1	Turn on the platform. 
2	Position the patient's armpits at the platform's yellow line. Close the band and press firmly to attach. 
3	Press Start. 

This page intentionally left blank.